

PRODUCT CATALOG

v8.24



°element®
DESIGNS

°element®
DESIGNS



TABLE OF CONTENTS

INSPIRATION GALLERY....	4
ALUMINUM FRAME DOORS....	20
profiles....	22
inserts....	56
FRAMELESS GLASS DOORS....	62
SLIDING DOORS....	64
dECOLuxe HIGH GLOSS SOLID ACRYLIC....	68
dECOMatte THIN FRONTS & SURFACES....	72
DECORATIVE HARDWARE....	74
FUNCTIONAL HARDWARE....	78
GOLA CHANNEL....	84
BACKPAINTED GLASS....	92
°eLUSION GLASS....	98
GLASS MARKERBOARDS....	100
°eCUBED SHELVING....	108
BASE SYSTEMS....	118
CONTRACT COATING....	124
SAMPLES....	126
ABOUT & CONTACT....	130



KITCHEN

Featured Products

Aluminum Frame Doors: AF003 Profile in Bronze Matte Finish with Bronze Clear Glass Inserts

Shelving Systems: °eCubed Shelving Systems in Bronze Matte Finish

GOLA Aluminum Channels in Bronze Matte Finish

Base Systems: BS001 Profile and Cuff in Bronze Matte Finish





CLOSET

Featured Products

Aluminum Frame Doors: AF012 Profile in Bronze Matte Finish
with Bronze Clear Glass Inserts







CLOSET

Featured Products

Aluminum Frame Doors: AF004 Profile in Graphite Finish
with Low-Iron Clear Glass Inserts

[< back to table of contents](#)





BATHROOM

Featured Products

Aluminum Frame Drawer Fronts: AF010 Profile in Natural Aluminum Finish
with Bronze Gloss Backpainted Glass Inserts

[< back to table of contents](#)





GARAGE

Featured Products

dECOLuxe Solid Acrylic Doors in Cobalt Blue

Aluminum Frame Doors: AF003 Profile in Brushed Stainless Finish
with Satin Glass Inserts using AVENTOS Lift System

[< back to table of contents](#)



RESIDENTIAL

Featured Products

Aluminum Frame Doors: AF003 Profile in Onyx Finish
with Bronze Clear Glass Inserts
Backsplash: Black Matte Backpainted Glass







OFFICE

Featured Products

Aluminum Frame Doors: AF002 Profile in Natural Aluminum Finish
with White Gloss Backpainted Glass Inserts





RETAIL

Featured Products

Shelving Systems: °eCubed Shelving Systems
in Modern Brass Finish with Customer Supplied Shelving

ALUMINUM FRAME CABINET DOORS

Our custom created hand built aluminum frame cabinet doors are a modern addition to residential and commercial interiors. Whether kitchen cabinet doors, office furniture doors, bathroom drawer fronts, closet storage, or sliding door systems, our aluminum frames are made to our customer's specifications and include all functional and decorative hardware borings. Our aluminum frames come in an incredible variety of finishes, which provide endless design options when paired with our premium glass, mirror, and other custom insert options. With no minimum order quantities and quick lead times, our contemporary aluminum frame doors and drawer fronts are ideal for both remodeling and new construction projects. We offer traditional European hinges which are easily incorporated into any casework applications. We also offer integrated hinges which utilize specially engineered AIR technology to create a sleek look without any visible hardware.



Image Courtesy of California Closets
Boston

Designer: Joeiny Muttini

AF004 Gold, Low-Iron Clear Glass



Image Courtesy of Top Notch Cabinets

AF013 Bronze Matte, Bronze Clear Glass



Image Courtesy of EuroCraft Cabinets

AF003 Brushed Stainless, Low-Iron Clear Glass

ALUMINUM DOOR PROFILES



AF002



AF003



AF004



AF006



AF007



AF009



AF010



AF011



AF012



AF013



AF014



AF015



AF016



AF017



AF210

CLICK ANY DOOR TO LEARN
MORE ABOUT THAT PROFILE 

FEATURES & BENEFITS

- 15 profile options in 12 finishes
- Over 60 insert options
- Custom manufactured to size (+/- 1mm)
- Fully assembled and ready to install
- Tempered safety glass
- Sustainably made in the USA

[< back to table of contents](#)

ALUMINUM FINISHES

ANODIZED FINISHES



natural aluminum (N)



brushed stainless (S)

COATED FINISHES

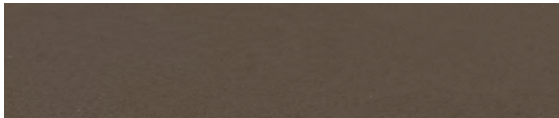

bronze matte (BZM)

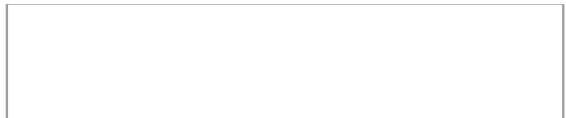

chalk (CK) (white matte)



onyx (X) (black matte)



black (B)

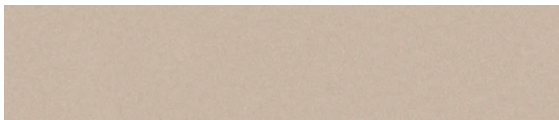

arctic silver (AS)



copper (CP)

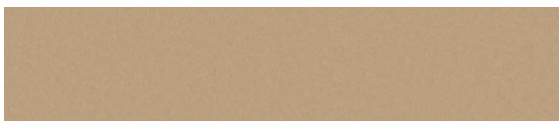

gold (GLD)

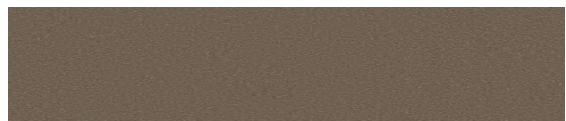

graphite (GR)

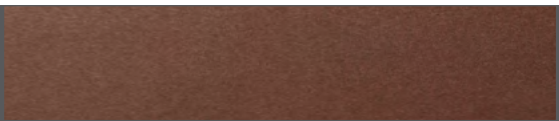

luxe bronze (LB)



modern brass (MB)

Element Designs offers various options in both anodized and coated finishes that are available on any aluminum products.

COATED FINISHES

- Fingerprint resistant
- Sustainable water-based coating
- Consistent finish without orange peel effect

[< back to table of contents](#)

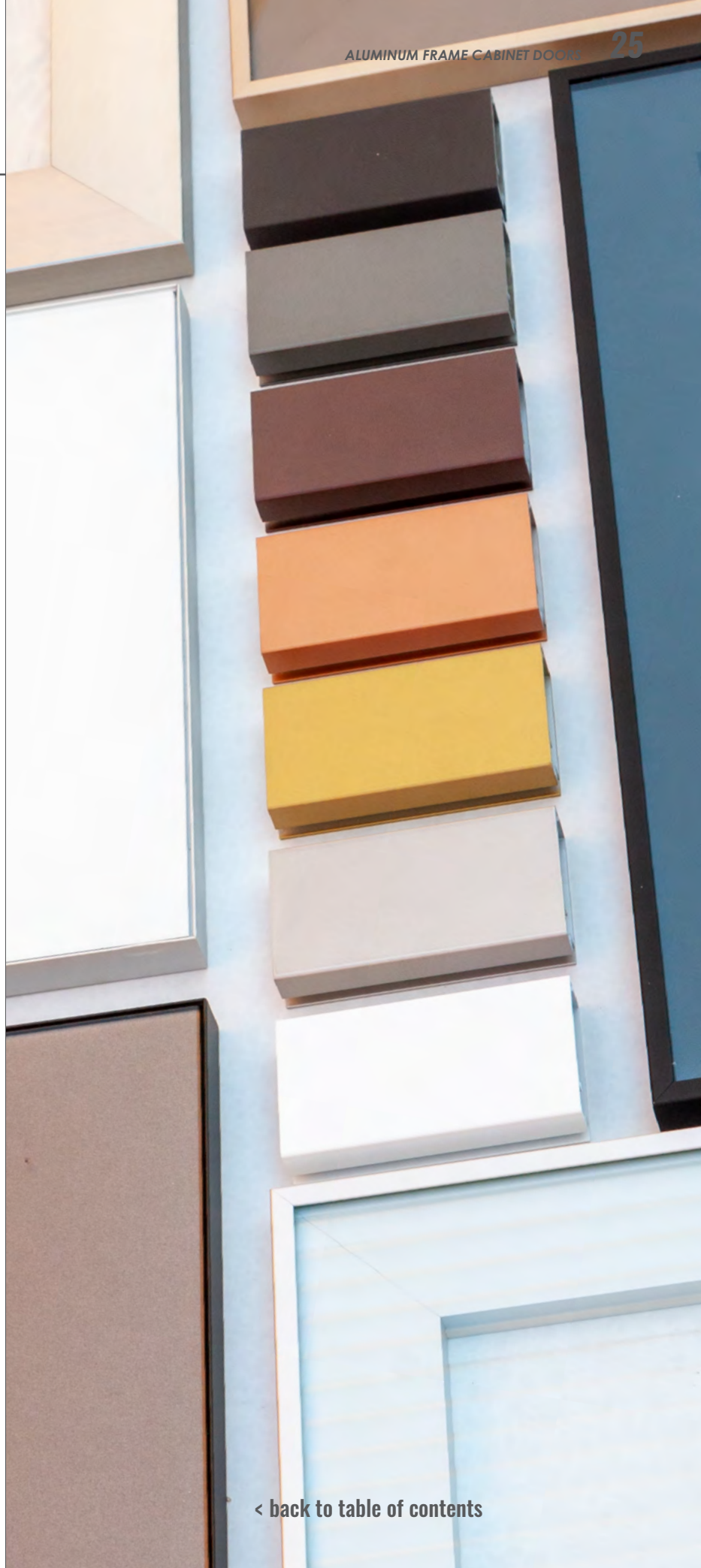



AF002 PROFILE

AF002

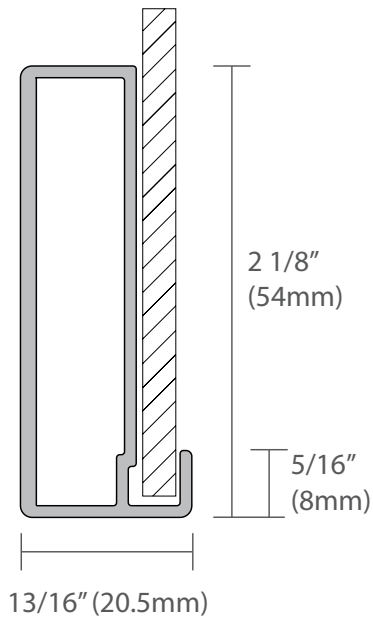

DESIGN GUIDELINES

- Maximum width & height = 96" (2438.4mm)
- Minimum width & height = 5.5" (140mm)
- Maximum square footage = 24 sf

INSERT SPECIFICATIONS

- 4mm (.157") with unpolished edge
- Handle hole locations must be specified at time of order if insert is tempered glass

HINGE INFORMATION

AF002 profile utilizes standard 35mm cup screw-on hinges:

- Blum 35mm cup hinge: H71T5550
- Blum Blumotion 35mm cup hinge: H71B3550
- Salice 35mm cup hinge: HC2P9A99
- More options available - contact Element Designs for details

Pictured: AF002 in Natural Aluminum Finish with Low-Iron Satin Glass Inserts



natural aluminum (N)



brushed stainless (S)

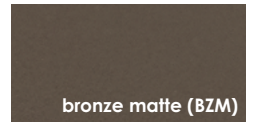

bronze matte (BZM)

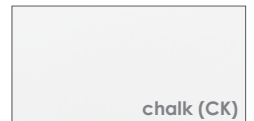

chalk (CK)



onyx (X)

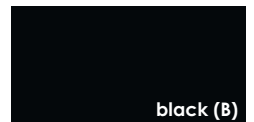

black (B)



arctic silver (AS)

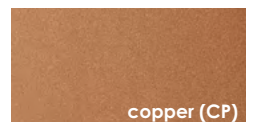

copper (CP)

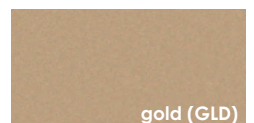

gold (GLD)

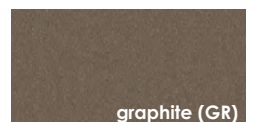

graphite (GR)



luxe bronze (LB)

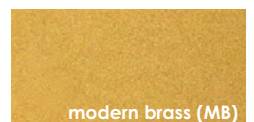

modern brass (MB)



AF003 PROFILE



AF003

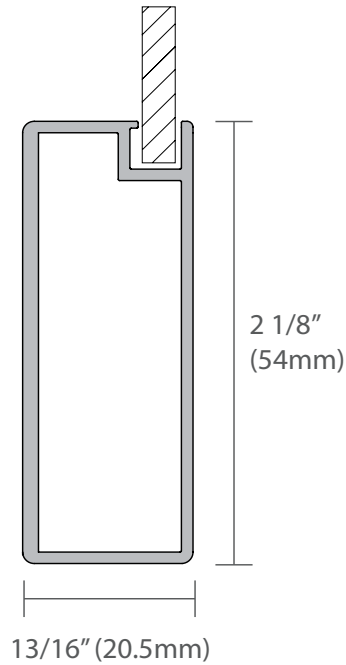

DESIGN GUIDELINES

- Maximum width & height = 96" (2438.4mm)
- Minimum width & height = 5.5" (140mm)
- Maximum square footage = 24 sf

INSERT SPECIFICATIONS

- 4mm (.157") with unpolished edge
- Handle hole can be drilled through the frame

HINGE INFORMATION

AF003 profile utilizes standard 35mm cup screw-on hinges:

- Blum 35mm cup hinge: H71T5550
- Blum Blumotion 35mm cup hinge: H71B3550
- Salice 35mm cup hinge: HC2P9A99
- More options available - contact Element Designs for details

Pictured: AF003 in Graphite Finish with Bronze Clear Glass Inserts

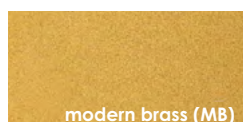
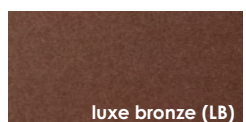
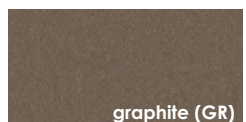
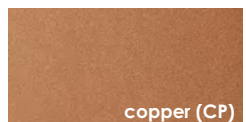
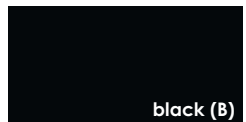
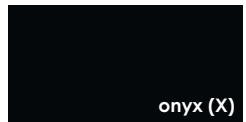
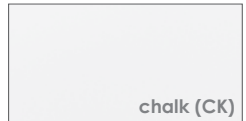
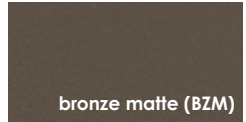
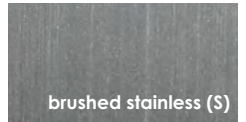

AFO04 PROFILE



AF004

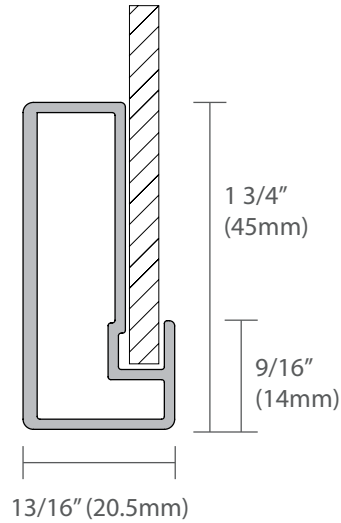

DESIGN GUIDELINES

- Maximum width & height = 96" (2438.4mm)
- Minimum width & height = 5.5" (140mm)
- Maximum square footage = 24 sf

INSERT SPECIFICATIONS

- 4mm (.157") with unpolished edge
- Handle hole locations must be specified at time of order if insert is tempered glass

HINGE INFORMATION

AF004 profile utilizes standard 35mm cup screw-on hinges:

- Blum 35mm cup hinge: H71T5550
- Blum Blumotion 35mm cup hinge: H71B3550
- Salice 35mm cup hinge: HC2P9A99
- More options available - contact Element Designs for details

Pictured: AF004 in Natural Aluminum Finish with Low-Iron Clear Glass Inserts



natural aluminum (N)

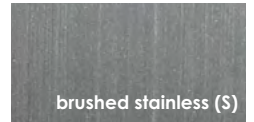

brushed stainless (S)

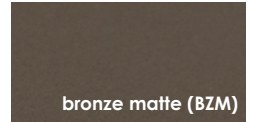

bronze matte (BZM)

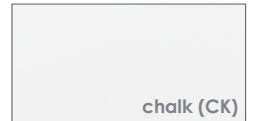

chalk (CK)

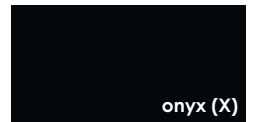

onyx (X)

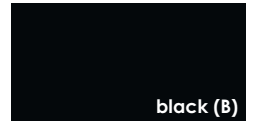

black (B)



arctic silver (AS)

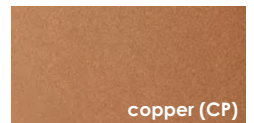

copper (CP)

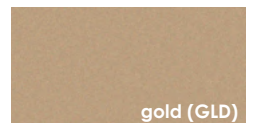

gold (GLD)

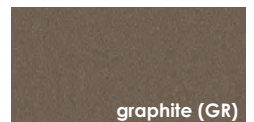

graphite (GR)



luxe bronze (LB)

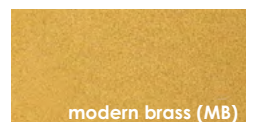

modern brass (MB)

AF006 PROFILE

AF006

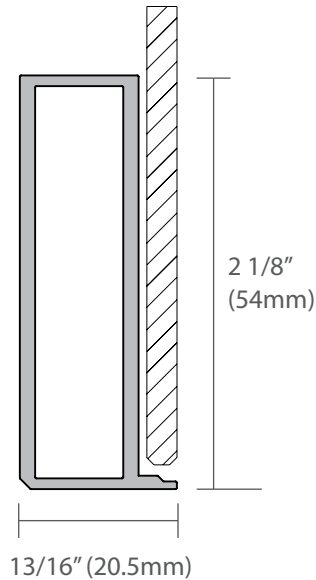

DESIGN GUIDELINES

- Maximum width & height = 96" (2438.4mm)
- Minimum width & height = 5.5" (140mm)
- Maximum square footage = 24 sf

INSERT SPECIFICATIONS

- 4mm (.157") with flat edge polish
- **Only available with backpainted glass and mirror inserts**
- Handle hole locations must be specified at time of order if insert is tempered glass

HINGE INFORMATION

AF006 profile utilizes standard 35mm cup screw-on hinges:

- Blum 35mm cup hinge: H71T5550
- Blum Blumotion 35mm cup hinge: H71B3550
- Salice 35mm cup hinge: HC2P9A99
- More options available - contact Element Designs for details

Pictured: AF006 in Brushed Stainless Finish with Slate Gloss Backpainted Glass Inserts and Low-Iron Satin Glass with Slate Backpainted Glass *elusion Border Inserts

natural aluminum (N)

brushed stainless (S)

bronze matte (BZM)

chalk (CK)

onyx (X)

black (B)

arctic silver (AS)

copper (CP)

gold (GLD)

graphite (GR)

luxe bronze (LB)

modern brass (MB)

AFO07 PROFILE



AF007

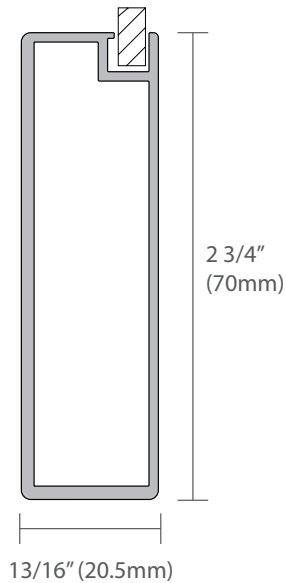

DESIGN GUIDELINES

- Maximum width & height = 96" (2438.4mm)
- Minimum width & height = 6.75" (172mm)
- Maximum square footage = 24 sf
- Ideal for AVENTOS HF Hinges (no visible hinge plates through glass)

INSERT SPECIFICATIONS

- 4mm (.157") with unpolished edge
- Handle hole can be drilled through the frame

HINGE INFORMATION

AF007 profile utilizes standard 35mm cup screw-on hinges:

- Blum 35mm cup hinge: H71T5550
- Blum Blumotion 35mm cup hinge: H71B3550
- Salice 35mm cup hinge: HC2P9A99
- More options available - contact Element Designs for details

Pictured: AF007 in Brushed Stainless Finish with Satin Glass Inserts



natural aluminum (N)

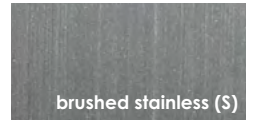

brushed stainless (S)

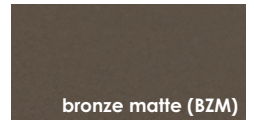

bronze matte (BZM)

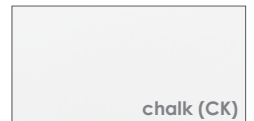

chalk (CK)



onyx (X)

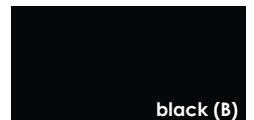

black (B)



arctic silver (AS)



copper (CP)



gold (GLD)

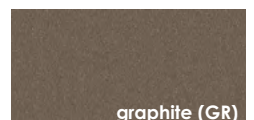

graphite (GR)

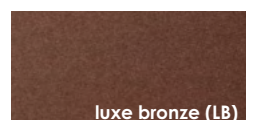

luxe bronze (LB)

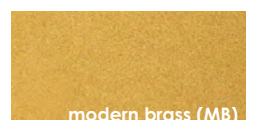

modern brass (MB)

AF009 PROFILE



AF009

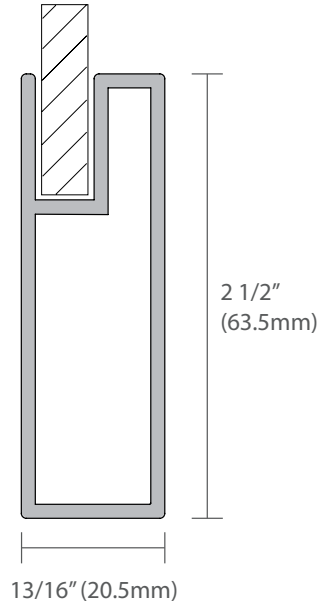

DESIGN GUIDELINES

- Maximum width & height = 96" (2438.4mm)
- Minimum width & height = 6.25" (159mm)
- Maximum square footage = 32 sf

INSERT SPECIFICATIONS

- 6mm (.236") with unpolished edge
- 4mm (.157") available only with special gasket
- Handle hole can be drilled through the frame

HINGE INFORMATION

AF009 profile utilizes standard 35mm cup screw-on hinges:

- Blum 35mm cup hinge: H71T5550
- Blum Blumotion 35mm cup hinge: H71B3550
- Salice 35mm cup hinge: HC2P9A99
- More options available - contact Element Designs for details

Pictured: AF009 in Natural Aluminum Finish with Clear Glass Inserts & Custom Etching



natural aluminum (N)

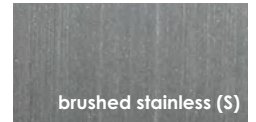

brushed stainless (S)

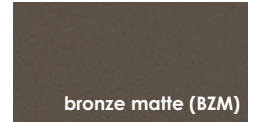

bronze matte (BZM)

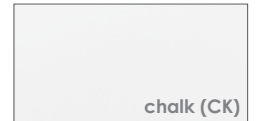

chalk (CK)

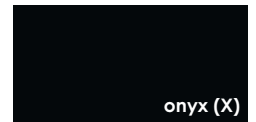

onyx (X)

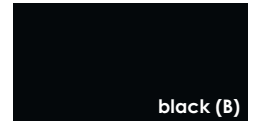

black (B)



arctic silver (AS)

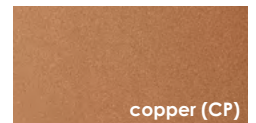

copper (CP)



gold (GLD)

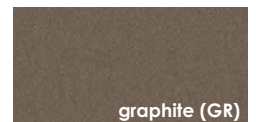

graphite (GR)

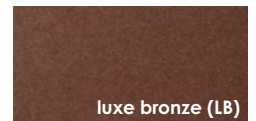

luxe bronze (LB)

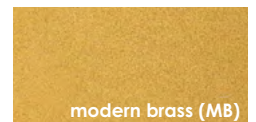

modern brass (MB)

AF010 PROFILE



AF010

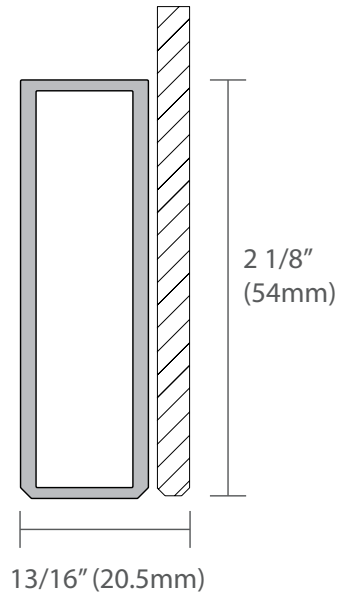

DESIGN GUIDELINES

- Maximum width & height = 96" (2438.4mm)
- Minimum width & height = 5.5" (140mm)
- Maximum square footage = 24 sf

INSERT SPECIFICATIONS

- 4mm (.157") with polished flat edge
- **Only available with backpainted glass and mirror inserts**
- Handle hole locations must be specified at time of order if insert is tempered glass

HINGE INFORMATION

AF010 profile utilizes standard 35mm cup screw-on hinges:

- Blum 35mm cup hinge: H71T5550
- Blum Blumotion 35mm cup hinge: H71B3550
- Salice 35mm cup hinge: HC2P9A99
- More options available - contact Element Designs for details

Pictured: AF010 in Natural Aluminum Finish with Custom Color Backpainted Glass Inserts & Custom Color Glass Magnetic Markerboards



natural aluminum (N)

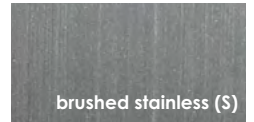

brushed stainless (S)

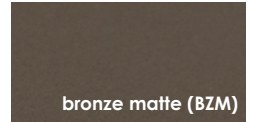

bronze matte (BZM)

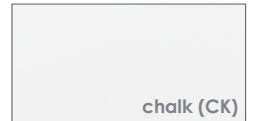

chalk (CK)

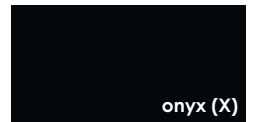

onyx (X)

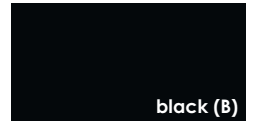

black (B)



arctic silver (AS)

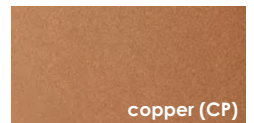

copper (CP)

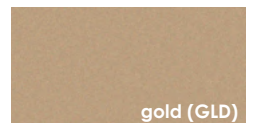

gold (GLD)

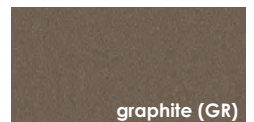

graphite (GR)



luxe bronze (LB)

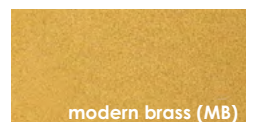

modern brass (MB)

AF011 PROFILE



AF011

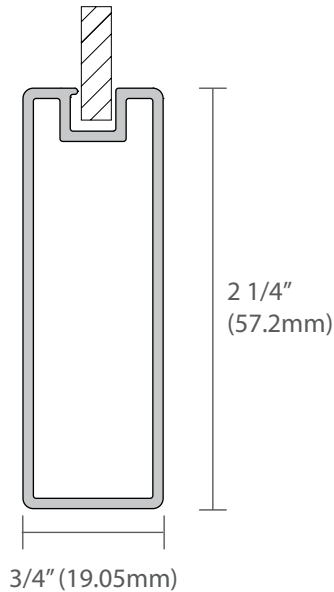

DESIGN GUIDELINES

- Maximum width & height = 96" (2438.4mm)
- Minimum width & height = 5.5" (140mm)
- Maximum square footage = 24 sf

INSERT SPECIFICATIONS

- 4mm (.157") with unpolished edge
- Handle hole can be drilled through the frame

HINGE INFORMATION

AF011 profile utilizes standard 35mm cup screw-on hinges:

- Blum 35mm cup hinge: H71T5550
- Blum Blumotion 35mm cup hinge: H71B3550
- Salice 35mm cup hinge: HC2P9A99
- More options available - contact Element Designs for details

Pictured: AF011 in Chalk Finish with Low-Iron Satin Glass Inserts



AFO 12 PROFILE

AF012 NARROW FRAME SALICE AIR INTEGRATED HINGE

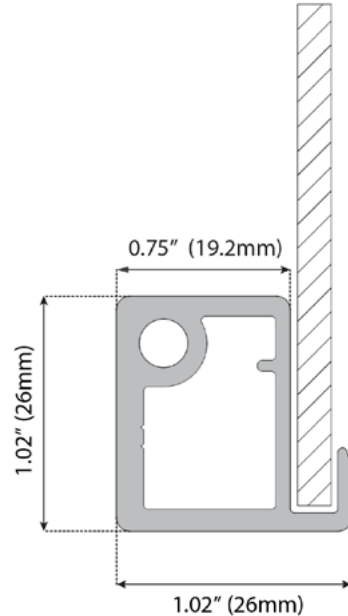

DESIGN GUIDELINES

- Fully concealed hinges located in upper and lower door corners
- Ideal for clear glass doors where cabinet interior is visible
- Maximum height = 106.25" (2699mm)
- Maximum width = 24" (610mm)
- Maximum door weight = 55 lbs (25 kg)
- Minimum width = 5.5" (139.7mm)
- Minimum height = 5.5" (139.7mm)
- Maximum square footage = 17.7 sf
- NOT recommended for drawer fronts or lift up door applications
- IMPORTANT: Door thickness = 1" (26mm)

INSERT SPECIFICATIONS

- 4mm (.157") with unpolished edge
- Handle hole locations must be specified at time of order if insert is tempered glass.

HINGE INFORMATION

AF012 profile requires SaliceAIR Hinges

Pictured: AF012 in Bronze Matte Finish with Bronze Clear Glass Inserts

[< back to table of contents](#)



AF013 PROFILE



AF013 NARROW FRAME SALICE AIR INTEGRATED HINGE

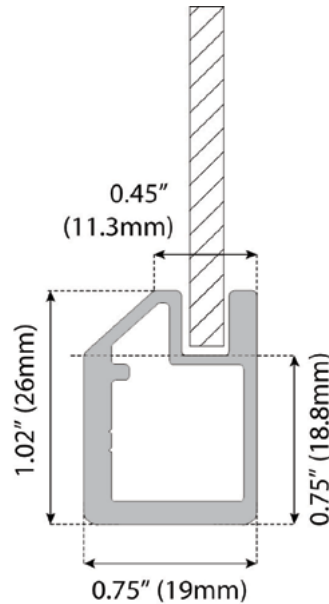

DESIGN GUIDELINES

- Fully concealed hinges located in upper and lower door corners
- Ideal for clear glass applications where cabinet interior is visible.
- Not recommended for drawer fronts and lift up applications
- Maximum height = 106.25" (2699mm)
- Maximum width = 24" (610mm)
- Maximum door weight = 55 lbs (25 kg)
- Minimum width = 5.5" (139.7mm)
- Minimum height = 5.5" (139.7mm)
- Maximum square footage = 17.7 sf
- IMPORTANT: Door thickness = 3/4" (18mm)

INSERT SPECIFICATIONS

- 4mm (.157") with unpolished edge
- Handle hole locations must be specified at time of order if insert is tempered glass.

HINGE INFORMATION

AF013 profile requires SaliceAIR Hinges

Pictured: AF013 in Chalk Finish with Clear Glass Inserts

[< back to table of contents](#)



AF014 PROFILE

AF014

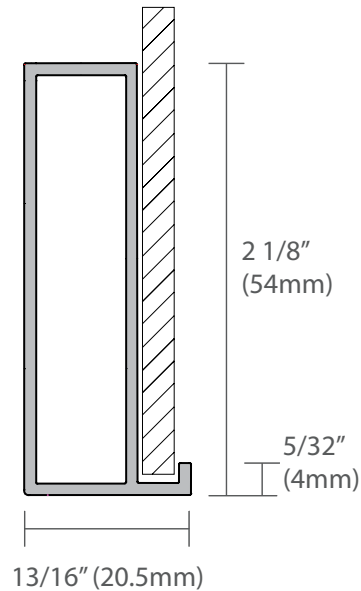

DESIGN GUIDELINES

- Maximum width & height = 96" (2438.4mm)
- Minimum width & height = 5.5" (140mm)
- Maximum square footage = 24 sf

INSERT SPECIFICATIONS

- 4mm (.157") with unpolished edge
- Handle hole locations must be specified at time of order if insert is tempered glass

HINGE INFORMATION

AF014 profile utilizes standard 35mm cup screw-on hinges:

- Blum 35mm cup hinge: H71T5550
- Blum Blumotion 35mm cup hinge: H71B3550
- Salice 35mm cup hinge: HC2P9A99
- More options available - contact Element Designs for details

Pictured: AF014 in Graphite Finish with Reeded (Horizontal) Glass Inserts



natural aluminum (N)

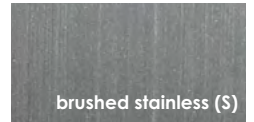

brushed stainless (S)

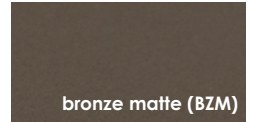

bronze matte (BZM)

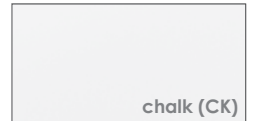

chalk (CK)

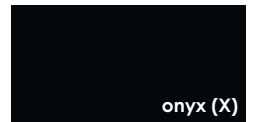

onyx (X)

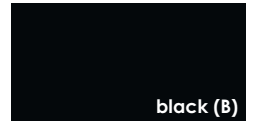

black (B)



arctic silver (AS)

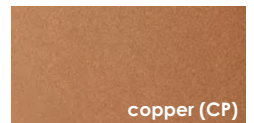

copper (CP)

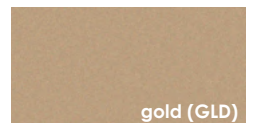

gold (GLD)

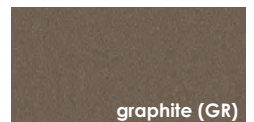

graphite (GR)



luxe bronze (LB)

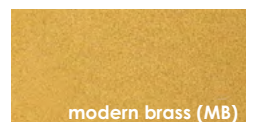

modern brass (MB)



AF015 PROFILE



AF015

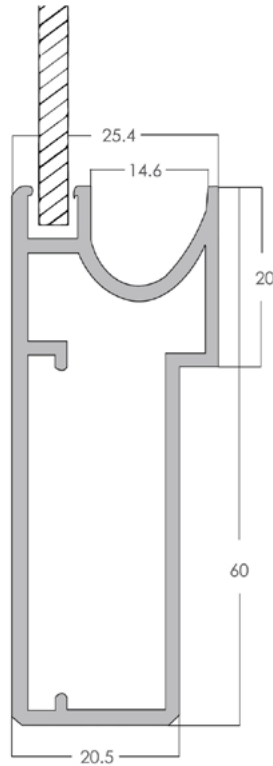

DESIGN GUIDELINES

- Maximum width & height = 96" (2438.4mm)
- Minimum width & height = 5.5" (140mm)
- Maximum square footage = 24 sf

INSERT SPECIFICATIONS

- 4mm (.157") with unpolished edge
- Handle hole can be drilled through the frame

HINGE INFORMATION

AF015 profile utilizes standard 35mm cup screw-on hinges:

- Blum 35mm cup hinge: H71T5550
- Blum Blumotion 35mm cup hinge: H71B3550
- Salice 35mm cup hinge: HC2P9A99
- More options available - contact Element Designs for details

Pictured: AF015 in Gold Finish with Grey Satin Glass Inserts



AF016 PROFILE



AF016 NARROW FRAME

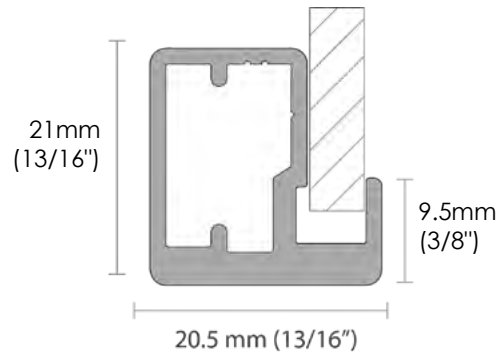

DESIGN GUIDELINES

- Maximum width & height = 96" (2438mm)
- Minimum width & height = 5.5" (140mm)
- Maximum square footage = 16 sf
- NOT recommended for drawer fronts

INSERT SPECIFICATIONS

- 4mm (.157") with unpolished edge
- Handle hole locations must be specified at time of order if insert is tempered glass

HINGE INFORMATION

AF016 profile utilizes special narrow frame European hinges:

- Blum self close full 15mm overlay aluminum door hinge: H73T550A
- Blum self close full 17mm aluminum door hinge: H71T950A
- Blum blumotion soft-close full 15mm aluminum door hinge: H71B950A
- Salice self close full 19mm aluminum door hinge: HC2Z6A99
- More options available - contact Element Designs for details

Pictured: AF016 in Brushed Stainless Finish with White Matte Backpainted Glass Inserts



natural aluminum (N)

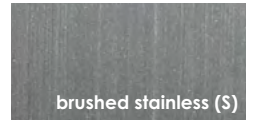

brushed stainless (S)

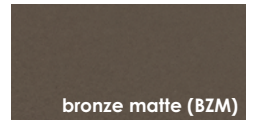

bronze matte (BZM)

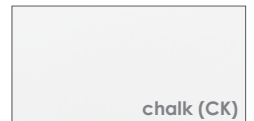

chalk (CK)

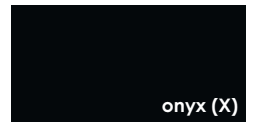

onyx (X)

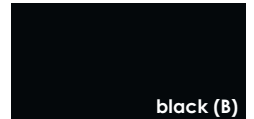

black (B)



arctic silver (AS)

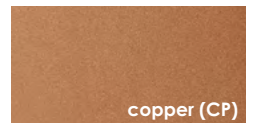

copper (CP)

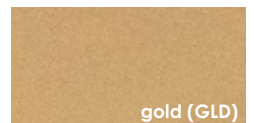

gold (GLD)

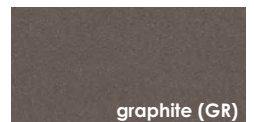

graphite (GR)



luxe bronze (LB)

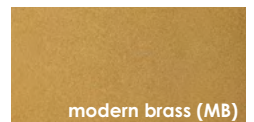

modern brass (MB)

AF017 PROFILE



AF017 NARROW FRAME

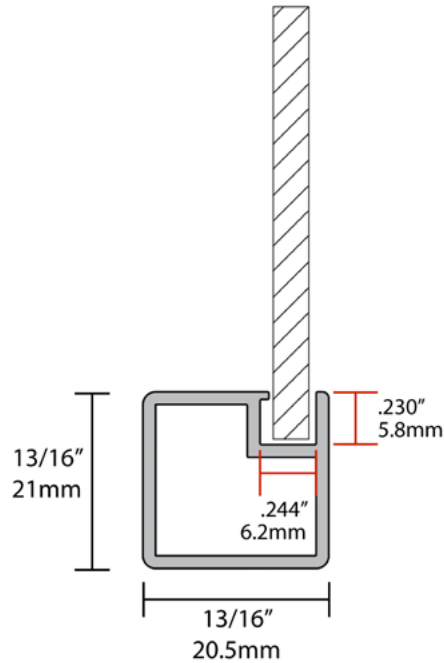

DESIGN GUIDELINES

- Maximum width & height = 96" (2438mm)
- Minimum width & height = 5.5" (140mm)
- Maximum square footage = 16 sf
- NOT recommended for drawer fronts

INSERT SPECIFICATIONS

- 4mm (.157") with unpolished edge
- Handle hole can be drilled through the frame

HINGE INFORMATION

AF017 profile utilizes special narrow frame European hinges:

- Blum self close full 15mm overlay hinge: H73T550A
- Blum self close 17mm overlay hinge: H71T950A
- Blum Blumotion soft close 15mm overlay hinge: H71B950A
- Salice self close 19mm overlay aluminum door hinge: HC2Z6A99
- More options available - contact Element Designs for details

Pictured: AF017 in Onyx Finish with Low-Iron Satin Glass Inserts

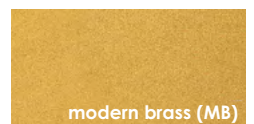
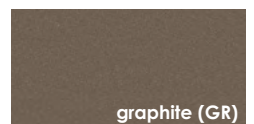
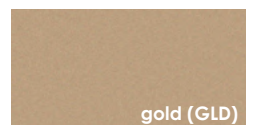
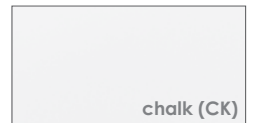
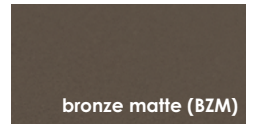
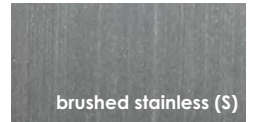

AF210 PROFILE

AF210 DOUBLE INSERT

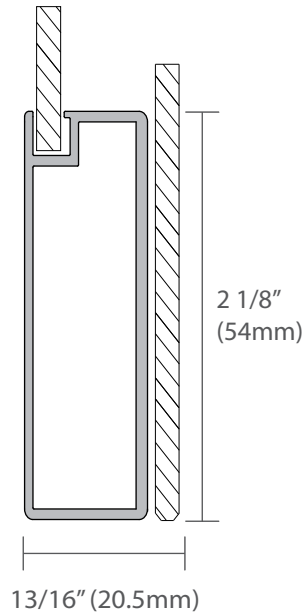

DESIGN GUIDELINES

- Maximum width & height = 96" (2438mm)
- Minimum width & height = 5.5" (140mm)
- Maximum square footage = 16 sf

INSERT SPECIFICATIONS

- 4mm (.157") with polished flat edge
- **Only available with backpainted glass and mirror inserts on door front**
- Handle hole locations must be specified at time of order if insert is tempered glass

HINGE INFORMATION

AF210 profile utilizes standard 35mm cup screw-on hinges:

- Blum 35mm cup hinge: H71T5550
- Blum blumotion 35mm cup hinge: H71B3550
- Salice 35mm cup hinge: HC2P9A99
- More options available - contact Element Designs for details

AF210 doors may require additional hinges based on weight.

Aluminum Frame Doors: AF210 Profile in Chrome Finish



STANDARD & PREMIUM GLASS & MIRROR INSERTS

DESIGN GUIDELINES

- Glass inserts are 5/32" (4mm) thick
- Etched and patterned side of glass faces in
- All glass is tempered safety glass, EXCEPT mirror which includes safety backer
- Listral d has a maximum height of 84" (2133mm)
- Reeded (vertical) has a maximum height of 82" (2083mm)
- Reeded (horizontal) has a maximum height of 58" (1473mm)

STANDARD GLASS & MIRROR



low-iron clear



low-iron satin



mirror



clear



satin

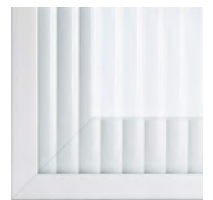

reeded

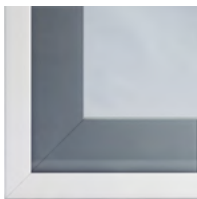

grey clear



bronze clear



listral d

PREMIUM GLASS & MIRROR

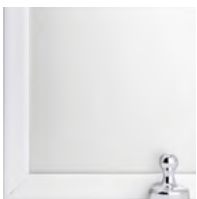

bronze satin

bronze satin mirror
(non-reflective)low-iron mirror
(non-reflective)

grey satin

grey satin mirror
(non-reflective)

low-iron mirror

BACKPAINTED GLASS INSERTS

STANDARD BACKPAINTED GLASS

Our backpainted glass comes in 10 standard colors which are offered in both matte and gloss. Color matching and custom colors available by request.



amarillo gloss

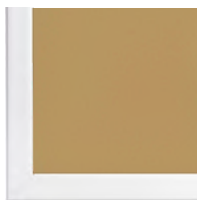

amarillo matte

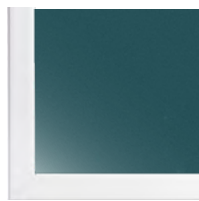

oasis gloss

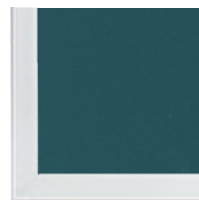

oasis matte

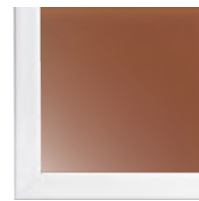

sienna gloss



sienna matte

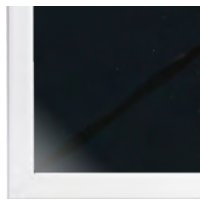

black gloss

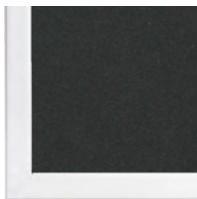

black matte

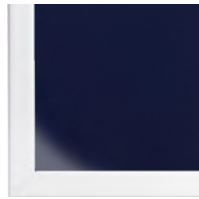

navy gloss



navy matte

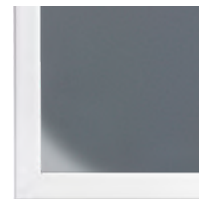

slate gloss

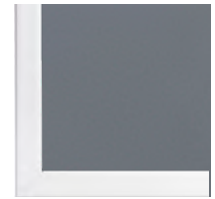

slate matte



mist gloss



mist matte



sand gloss



sand matte



cream gloss



cream matte

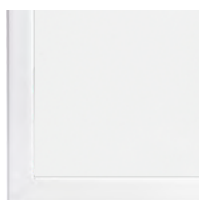

white gloss

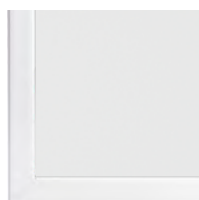

white matte

DESIGN GUIDELINES

- High quality water based paint on low-iron glass
- Tempered safety glass
- All backpainted glass comes with light grey protective painted backer

RECYCLED LEATHER

Ecodomo® Recycled Leather is a universal surface material that can be integrated in lieu of wood veneer in any interior space. The proprietary resin top coat delivers stain, wear, and water resistance.



**Recycled Leather Sample Kit
available in our online sample
store.**



grey umber
buffalo

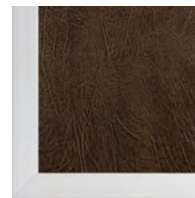

cocoa buffalo

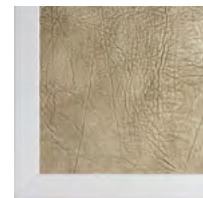

gold grey metallic
buffalo



black shagreen



pebble shagreen



grey stone
shagreen

DESIGN GUIDELINES

- Inserts are 5/32" (4mm) thick
- Recycled Leather Veneer on both sides
- Leather no longer in our standard program, including grey thunder buffalo, coal buffalo and antique brown walrus are still available.
- Suitable for horizontal and vertical applications,
- Available as cut-to-size panels.

3FORM[®] RESIN

3FORM[®] is a one-of-a-kind material with timeless textures made of eco-friendly materials. Their resins are adaptable, durable, sustainable, and modern.



gold weave
metallic

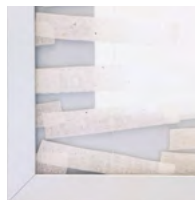

tribe pure



vera pure



villa pure



woven lotka pure



linea ivory



quattro carbon

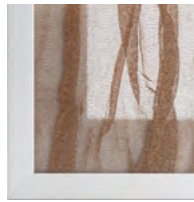

swept gold



swept silver



wisp silver



**3Form Sample Kit available in
our online sample store.**

DESIGN GUIDELINES

- Inserts are 5/32" (4mm) thick
- Sandstone finish on front and back
- Patterns no longer in our standard program, including ensign, fossil leaf, glint gold, kathali greys, mari seamless, starcrossed shadow, strand iron, struck pure, thatch, and weld silver are still available.
- Available as cut-to-size panels.
- **3Form Architectural Resin inserts contain organic materials and may vary in color and density due to natural conditions**

ELUSION GLASS INSERTS



Image Courtesy of Simmons & Co

DESIGN GUIDELINES

- Opaque backpainted border around perimeter of glass
- Ideal for aluminum frame profiles AF006 and AF010
- Works best with low-iron, bronze, and grey clear and satin glass.
- Standard border width = 2 1/4" (57mm)
- Custom sizes and colors available upon request
- High end paint finish with light grey protective painted backer
- Matte side faces in when using satin glass unless otherwise specified
- Glass inserts are 5/32" (4mm) thick
- Other applications include table, island, desk and counter tops & shelving

PROFILE & FINISH EXAMPLES



AF006S with clear glass & black °elusion border

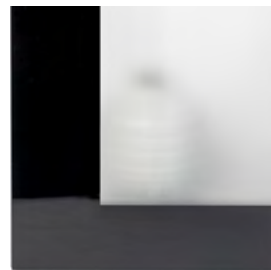

AF010X with low-iron satin & black °elusion border



Pictured Left: AF010 Onyx Profile with Grey Clear Glass & a Black °elusion Border

Pictured Top of Page: AF010 Bronze Matte Profile with Low-Iron Clear Glass & a Custom Sized Bronze °elusion Border

[< back to table of contents](#)

FRAMELESS GLASS DOORS

FRAMELESS GLASS DOORS



FEATURES & BENEFITS

- Maximum width & height = 84" (1219mm)
- Minimum width & height = 5.5" (102mm)
- Maximum square footage = 14 sf
- Thickness is 6mm (1/4")
- Glass is flat edge polished
- NOT recommended as drawer fronts

GLASS OPTIONS

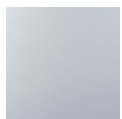

low-iron
clear



low-iron
satin



clear

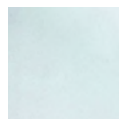

satin



grey clear



bronze
clear

HINGE TYPE - BLUMOTION CRISTALLO by Blum



Element Designs is the
EXCLUSIVE supplier of the
Blumotion CRISTALLO Hinge in
North America.

Pictured Left: Frameless Glass Doors using Low-Iron Clear Glass

[< back to table of contents](#)

SLIDING DOOR SYSTEMS



Our sliding door systems are the perfect addition to closets, pantries, offices, cabinets and furniture designs. Sliding doors are custom manufactured to size (+/- 1mm) and arrive with hardware pre-installed (if applicable). Sliding door systems can be fully customized with your choice of aluminum frame profile, finish and insert options including glass, mirror, and dECOLuxe. These systems can also be built with divider rails to create a multiple pane appearance using the same insert type or you may combine different insert options for a truly custom design. No minimum order quantities, quick lead times. Sustainably made in the USA.



AF003 Natural Aluminum, Clear Glass



AF003 Natural Aluminum, Satin Glass, Divider Rails

[< back to table of contents](#)

SLIDING DOORS

SLIDING DOOR SYSTEMS

DESIGN GUIDELINES

- Sliding system includes top guides and bottom tracks.
- Single, Double & Triple tracks available
- Multiple planes of motion
- Inset or surface mount bottom track
- Door weight capacity: 97 lbs
- Soft close mechanisms available
- Max door height 96"

PROFILE OPTIONS:



AF002



AF003



AF004



AF006



AF007



AF009



AF010



AF011



AF014



AF015



AF210



natural aluminum (N)

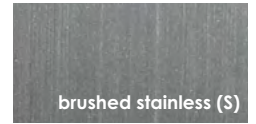

brushed stainless (S)

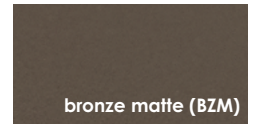

bronze matte (BZM)

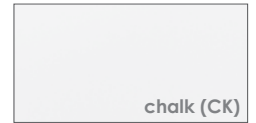

chalk (CK)

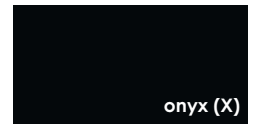

onyx (X)

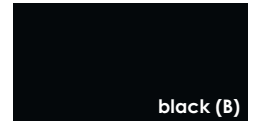

black (B)



arctic silver (AS)

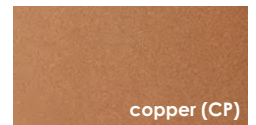

copper (CP)

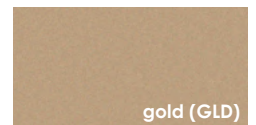

gold (GLD)

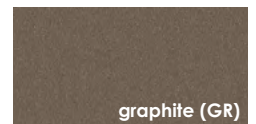

graphite (GR)

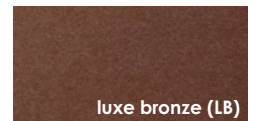

luxe bronze (LB)

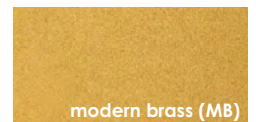

modern brass (MB)

Pictured: AF004 Profile in Natural Aluminum Finish with Low-Iron Satin Glass Inserts

dECoLuxE
HIGH GLOSS
SOLID ACRYLIC

dECOLuxe Solid Acrylic combines luxury and decor with eco-friendly materials. Made from 100% recycled acrylic and is 100% recyclable. dECOLuxe is available in 8 beautiful colors in both 4mm and 18mm thickness. Colors options include alpine white, anthracite, black, cobalt blue, light grey, stone grey, turquoise, and white. dECOLuxe is waterproof and UV resistant. It works beautifully as both cabinet doors and drawer fronts. Ideal spaces include kitchens, both indoor and outdoor, garages, and more.



Alpine White dECOLuxe



Alpine White dECOLuxe



Stone Grey dECOLuxe, Integrated Pulls

HIGH GLOSS DOORS & DRAWER FRONTS



DECOLUXE HIGH GLOSS SOLID ACRYLIC

COLOR OPTIONS



alpine white



anthracite



black



cobalt blue



signal red



light grey

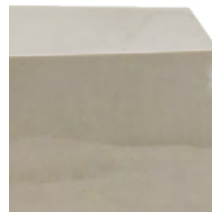

stone grey



turquoise



white

FEATURES & BENEFITS

- Waterproof and UV fade resistant
- Made out of 100% recycled acrylic & 100% recyclable
- Available in 4mm and 18mm thickness
- Acrylic size sheet is 1m x 3m (39.37" x 118.11")
- High gloss finish on all surfaces

EDGE FINISH OPTIONS

straight edge



1mm



INTEGRATED PULL OPTIONS

straight



curved



Pictured: Stone Grey dECOLuxe

[< back to table of contents](#)

MATTE FRONTS & SURFACES

DECOMATTE THIN FRONTS & SURFACES

COLOR OPTIONS



WHITE
bianco kos

GREY
grigio efeso

STONE
grigio londra

BLACK
nero ingo

FEATURES & BENEFITS

- Applications include cabinet doors, drawer fronts, counter tops and shelving.
- Ultra matte, anti-fingerprint, soft touch and completely opaque surface
- Extremely durable and has thermal healing capabilities for superficial micro-scratches
- Made with innovative FENIX material

DESIGN GUIDELINES

- 12mm thickness
- Requires Blum thin front solutions for vertical applications. CLIP top hinges for cabinet doors, AVENTOS mounting plates for lift doors, and LEGRABOX brackets for drawer fronts
- Maximum Panel Size 48" x 118"

EDGE FINISH OPTIONS

straight edge



12mm

1mm



12mm

INTEGRATED PULL OPTION

straight



Pictured: Black dECOMatte Drawer Fronts. Image Courtesy of Blum.

DECORATIVE HARDWARE: FINGER PULLS



FINGER PULLS

DESIGN GUIDELINES



- Mounts to back of door or drawer front
- Backplate Height: 9/16" (15mm)
- Finger Pull Height: 1 11/16" (42mm)
- Standard sizes include: 3", 6", 9" & 12"
- Flush mount NOT available with AF010 or AF014
- AF002 flush mount available with 3" ONLY.
- Brushed Stainless finish ONLY available in 3".



Flush Mount

Surface Mount

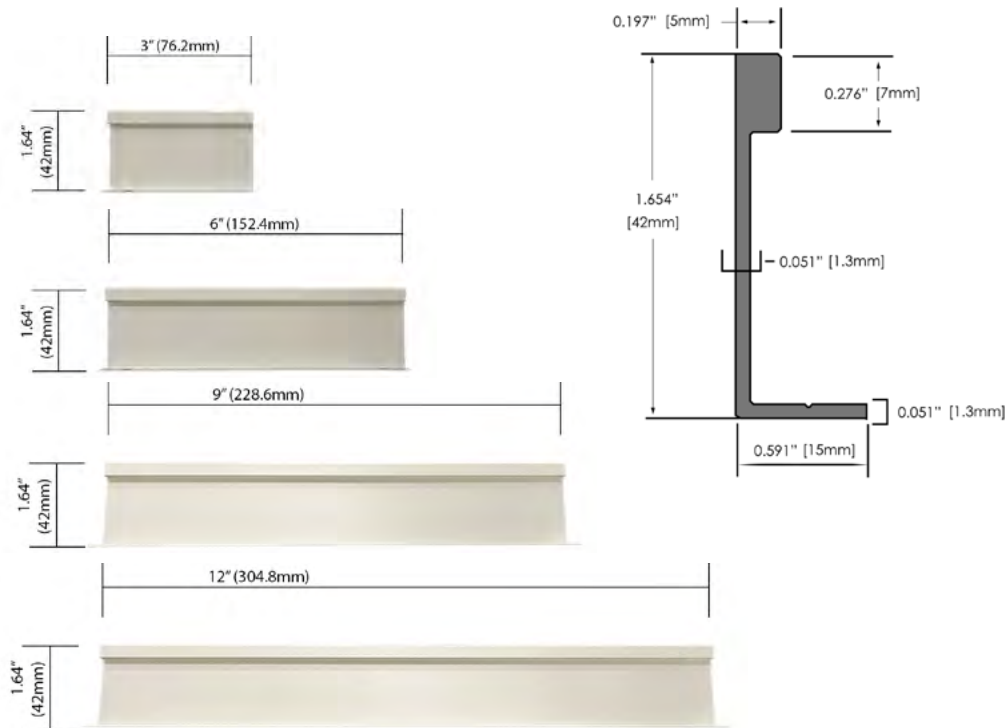

natural aluminum (N)



brushed stainless (S)



bronze matte (BZM)

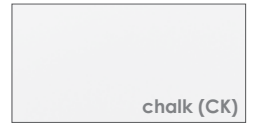

chalk (CK)



onyx (X)

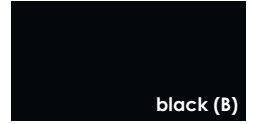

black (B)



arctic silver (AS)



copper (CP)

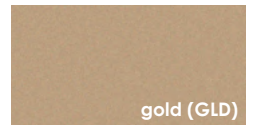

gold (GLD)

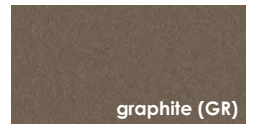

graphite (GR)



luxe bronze (LB)

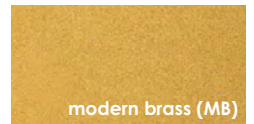

modern brass (MB)

BEVELED PULLS

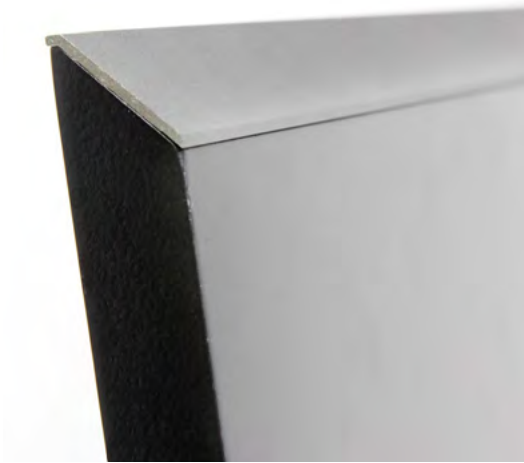

DESIGN GUIDELINES

- Used to create an integrated handle on wood doors
- Adds subtle design detail with anodized or coated finishes
- Length options: in 120" (3048mm), 90" (2286mm)
- Custom lengths available upon request
- Machining available for custom lengths
- Available in all anodized and coated finishes
- **Not for use with aluminum frame doors**

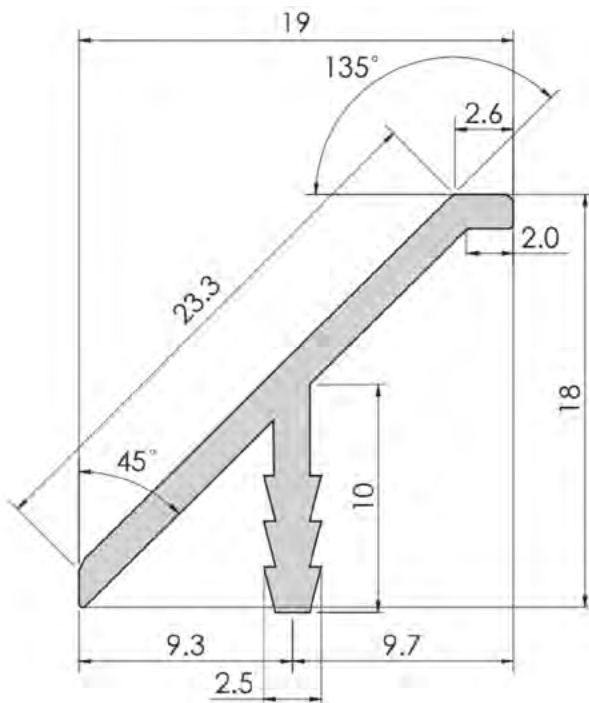

[< back to table of contents](#)



FUNCTIONAL HARDWARE

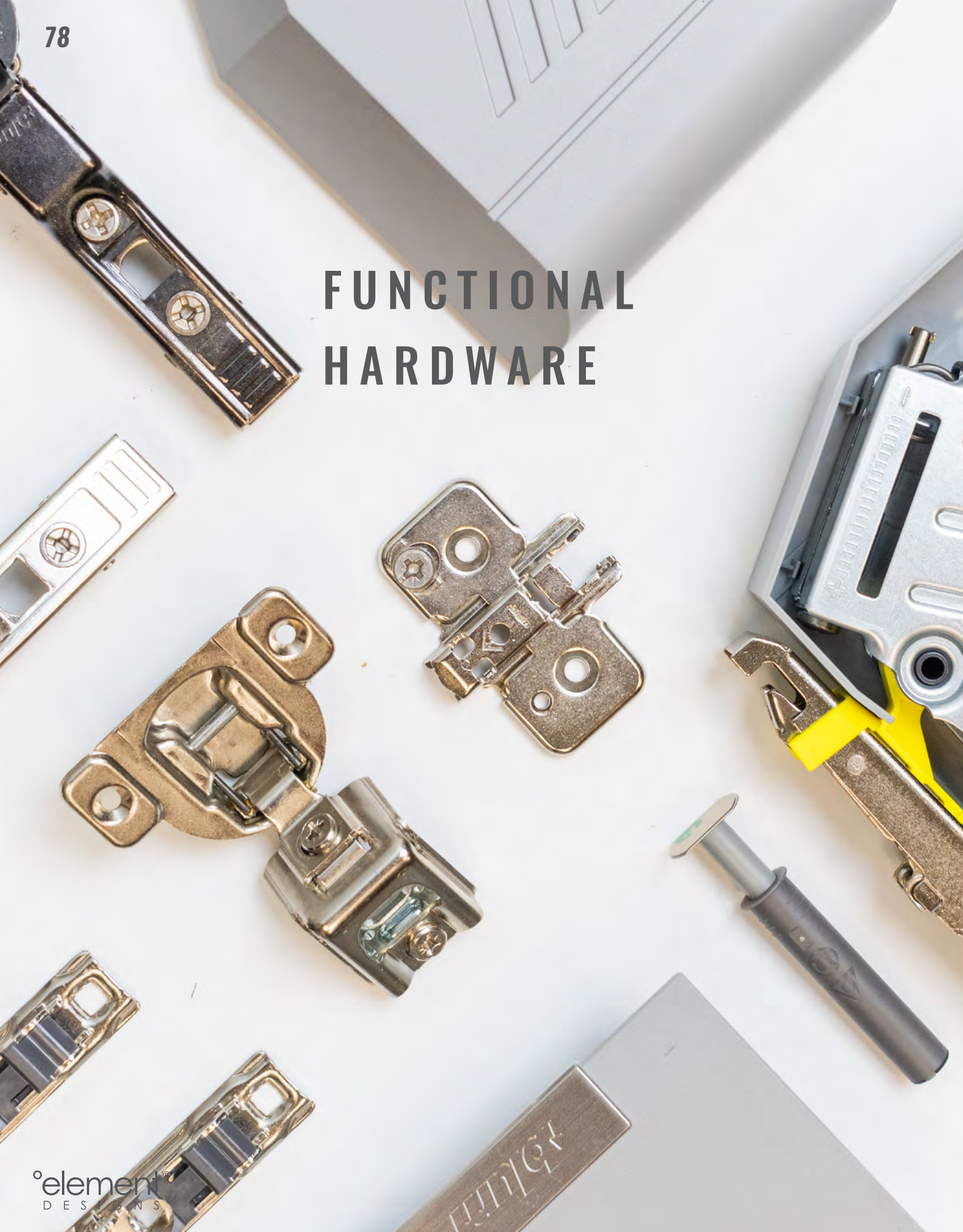

Element Designs' decorative hardware is a beautiful modern collection of pulls and knobs that have been hand selected to coordinate with almost any contemporary casework application. Our decorative hardware is available in all twelve aluminum finish options including both anodized and coated. This makes them the perfect accent to match any of our other aluminum products.



Concealed Hinge



AVENTOS HF Lift System



AIR Hinge

BLUM HARDWARE

BLUM AVENTOS LIFT HARDWARE

Blum AVENTOS lift hardware offers a wide variety of door opening options to suit many design needs. We offer the following lift hardware: HF - Bi-Fold, HL - Lift Up, HS - Up and Over, plus HK-Top, HK-XS, and HK-S Stay Lift systems.



AVENTOS HF - Bi-Fold

two part door front that folds in the center when opening



AVENTOS HL - Lift Up

single door front that lifts up parallel to the cabinet



AVENTOS HS - Up and Over

single door front that swings over the top of the cabinet



AVENTOS HK-Top - Stay Lift

single door front that lifts upward; uses easy install cabinet side lift mechanism



AVENTOS HK-XS - Stay Lift

single door front that lifts upward; uses hinges and cabinet side lift mechanism



AVENTOS HK-S - Stay Lift

single door front that lifts smaller doors upward; uses cabinet side lift mechanism

Online support for ordering AVENTOS hardware is available through the AVENTOS Wizard within our online ordering portal, elementONLINE. For more information on how to use the AVENTOS Wizard and other features within elementONLINE please visit our [website](#).

BLUM HINGES

We are proud to offer an extensive selection of Blum concealed European hinges to meet your functional hardware needs. Visit our [website](#) to see the entire collection of hinges and plates.



BLUMOTION
Blum® Narrow Frame Hinge
straight arm, 95°, 15mm overlay, soft close with deactivation switch

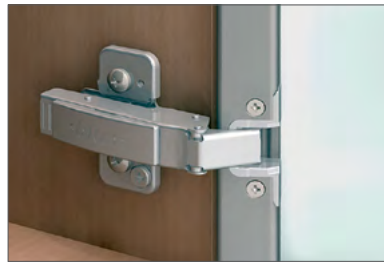

Blum® Narrow Frame Hinge
straight arm, 120°, 15mm overlay, self close



BLUMOTION
Blum® 35mm Cup Hinge
straight arm, 110°, soft close with deactivation switch



Blum® 35mm Cup Hinge
straight arm, 120°, self close

For additional Blum hardware options visit element-designs.com

SALICE HARDWARE

SALICE HINGES

We are proud to offer an extensive selection of Salice concealed, European hinges to meet your functional hardware needs. Visit our website to see the entire collection of hinges and plates.



Salice Silentia Narrow Frame Hinges
soft close
Nickel (Shown)
matching cover caps available in all finishes, except brushed stainless.



**Salice Push-to-Open
Narrow Frame Hinges**
push-to-open
Nickel (Shown) or Titanium Finish

*Magnetic push hardware also available for push-to-open hinges



Salice Silentia Wide Frame Hinges
soft close, free-swing
Nickel (Shown) or Titanium Finish



**Salice Push-to-Open
Wide Frame Hinges**
push-to-open
Nickel (Shown) or Titanium Finish

*Magnetic push hardware also available for push-to-open hinges

SALICE AIR HINGES

The Salice AIR Hinge is installed directly into the top and bottom of the cabinet, making it virtually invisible and ideal for glass cabinet doors. Salice AIR Hinges are available only on aluminum door profiles AF012 and AF013.



Salice AIR Hinge
push-to-open, free-swing
Nickel (Shown) or Titanium Finish



Salice AIR Hinge
soft-close
Nickel or Titanium Finish (Shown)

*Magnetic push hardware also available for push-to-open hinges



GOLA CHANNEL



Pictured: GOLA J-Channel & C-Channel in Gold

Image Courtesy of Essence Cabinets

GOLA aluminum channels are a simple way to achieve hardware-free cabinetry not only with their sleek design, but without additional fabrication required during the manufacturing of both cabinet doors and drawer fronts. GOLA profiles are easily installed into cabinets with concealed brackets. The spacer channels provide ample room for fingertips so that the doors and drawer fronts themselves can be used to open and close instead of exposed handles and pulls.



J-Channel & C-Channel, Stainless Nickel Finish



Aluminum Spacer Single & Double, Stainless Nickel Finish



C-Channel, Gold Finish

J-CHANNEL



GOLA ALUMINUM J-CHANNEL (GC-8006)

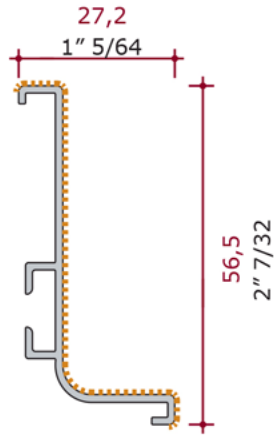

Mounts inside of cabinet, under countertop to provide space for fingers to reach the back of cabinet door or drawer front.

DESIGN GUIDELINES

- Length options: 90" (2286), 120" (3048)
- Custom cut-to-size lengths available upon request
- For necessary mounting components, including open and closed end caps, see the GOLA technical manual which can be found on our website

Pictured: GOLA J-Channel & C-Channel in Stainless Nickel Finish

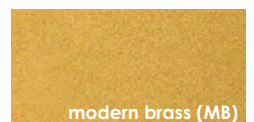
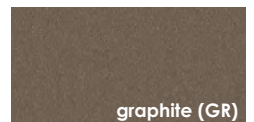
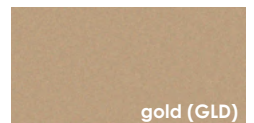
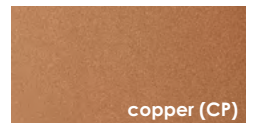
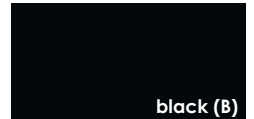
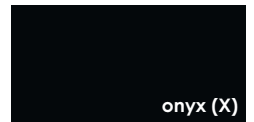
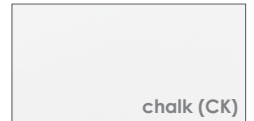
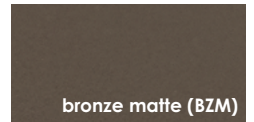

C-CHANNEL



GOLA ALUMINUM C-CHANNEL (GC-8007)

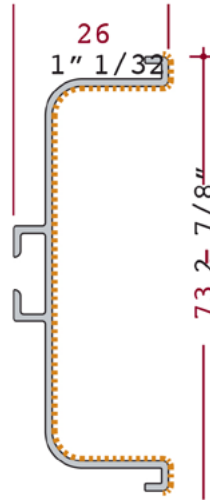
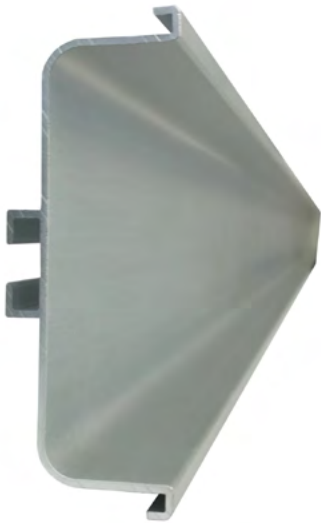

Mounts inside of cabinet, between drawer fronts or doors to provide space for fingers to reach the back of cabinet door or drawer front.

DESIGN GUIDELINES

- Length options: 90" (2286), 120" (3048)
- Custom cut-to-size lengths available upon request
- For necessary mounting components, including open and closed end caps, see the GOLA technical manual which can be found on our website

Pictured: GOLA C-Channel in Gold Finish

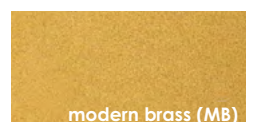
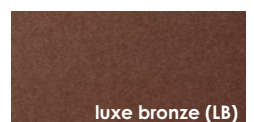
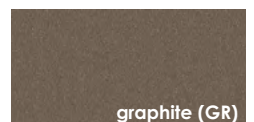
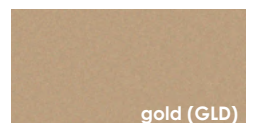
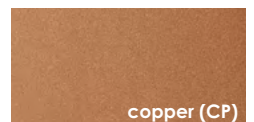
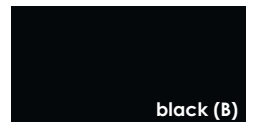
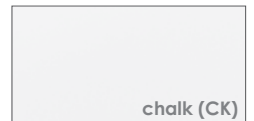
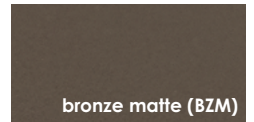

VERTICAL & UPPER CABINET CHANNEL



GOLA DOUBLE VERTICAL CHANNEL (GC-8059)

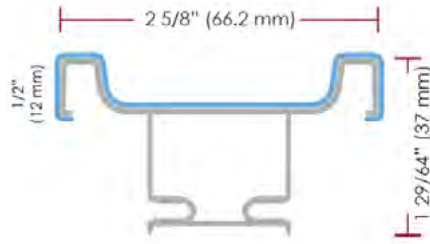

GOLA SINGLE VERTICAL CHANNEL (GC-8074)

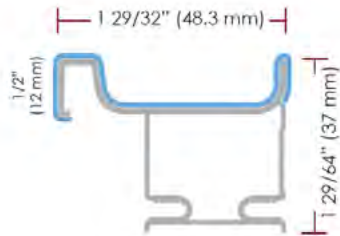

Vertical Channels mount vertically in the center between two cabinet doors to provide space for fingers to reach behind doors for easy opening.

DESIGN GUIDELINES

- Length options: 90" (2286), 105" (2667)
- Custom cut-to-size lengths available upon request
- For necessary mounting components, see the GOLA technical manual which can be found on our website

GOLA UPPER CABINET CHANNEL (GC-1730)

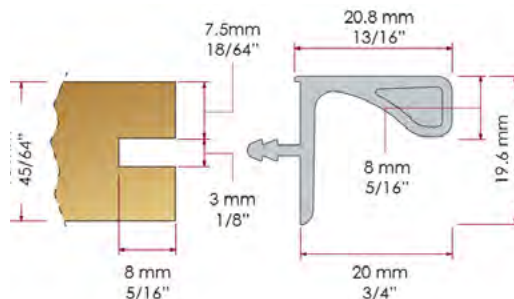

Pictured: GOLA Single Vertical Channel & Double Vertical Channel in Stainless Nickel Finish

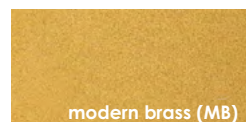
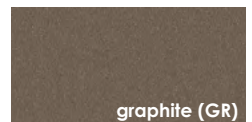
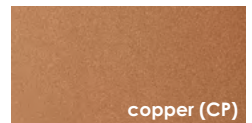
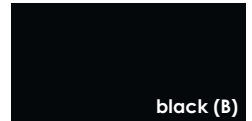
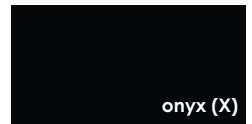
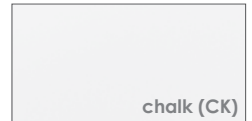
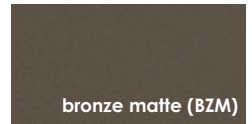

BACKPAINTED GLASS & MARKERBOARDS

Our backpainted glass is available in ten standard colors, 189 non-standard colors as well as custom color match options. It is ideal for backsplashes, tabletops, countertops, shelving and more. All backpainted glass is tempered and utilizes low-iron glass for color clarity. Available in 4mm, 6mm, 10mm, and 12mm thickness's making it perfect for any application. It is also available in standard gloss and matte finishes. Backpainted glass by Element Designs adds beautiful detail to residential and commercial interiors.

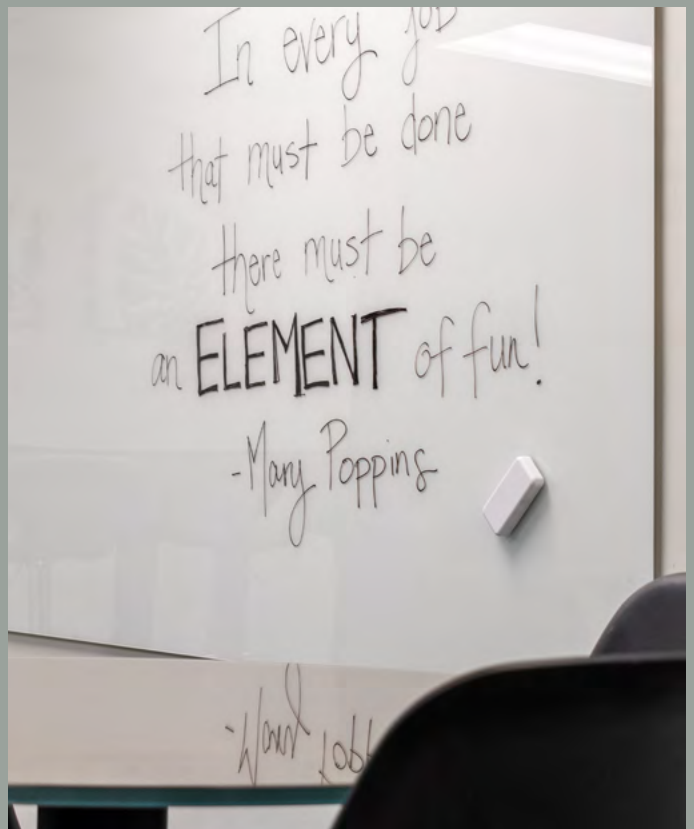

Image Courtesy of California Closets Tampa Bay
All Rights Reserved

Custom Color Gloss Backpainted Glass



Mocha Gloss Backpainted Glass



White Gloss Glass Magnetic Markerboard

BACKPAINTED GLASS



BACKPAINTED GLASS

DESIGN GUIDELINES

- Maximum size for 4mm is 48" x 96" (1219mm x 2438mm)
- Maximum size for 6mm, 10mm, & 12mm is 60" x 120" (1524mm x 3048mm)
- Minimum width and length for polished flat edge is 4" (101.6mm)
- Custom color matching requires sample approval.

EDGE FINISH OPTIONS

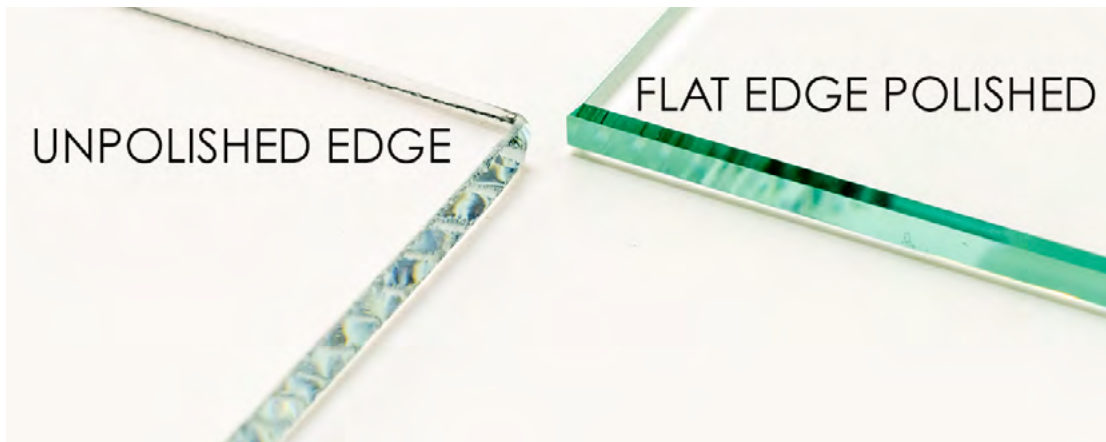

THICKNESS & FINISH OPTIONS

	4mm (5/32")	6mm (1/4")	10mm (3/8")	12mm (1/2")
Unpolished Edge	✓	✓		
Flat Edge Polished	✓	✓	✓	✓
Gloss Finish	✓	✓	✓	✓
Matte Finish	✓	✓	✓	✓

Glass Thickness	Edgework	Size Tolerance (metric)
4mm (5/32")	Unpolished	+1.6mm, -1.6mm
4mm (5/32")	Polished	+0, -1.6mm
6mm (1/4")	Unpolished	+1.6mm, -1.6mm
6mm (1/4")	Polished	+0, -3.2mm
10mm (3/8")	Polished	+0, -3.2mm
12mm (1/2")	Polished	+0, -3.2mm

Pictured Left: Backsplash in Black Matte Backpainted Glass



BACKPAINTED GLASS COLOR OPTIONS

All colors available in 4mm, 6mm, 10mm, and 12mm thicknesses. Applications include magnetic glass markerboards, wall panels, partitions, backsplashes, table tops, counter tops, desk tops, closet islands, trade show flooring, and more.

STANDARD COLORS

All standard colors are offered in both matte and gloss finishes.



amarillo gloss

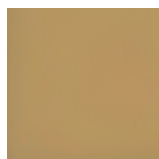

amarillo matte



oasis gloss

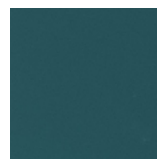

oasis matte



sienna gloss



sienna matte

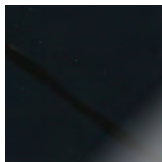

black gloss

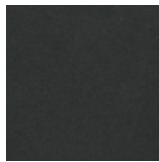

black matte



navy gloss

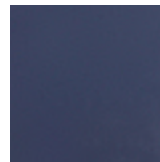

navy matte



slate gloss



slate matte

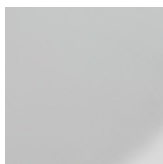

mist gloss

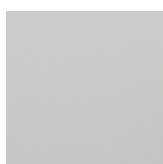

mist matte



sand gloss

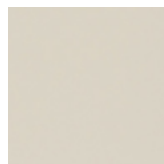

sand matte



cream gloss

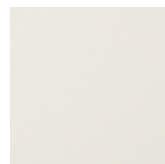

cream matte

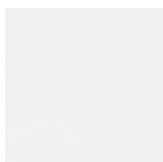

white gloss

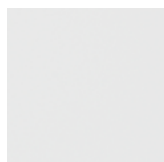

white matte

CUSTOM COLORS

Custom color matching is available for all major paint manufacturer color selections, and customer provided samples. Custom colors require sample approval.

Pictured: Backpainted Glass in White Gloss & White Matte

[< back to table of contents](#)

° ELUSION GLASS

ELUSION GLASS

°elusion glass is a backpainted border that creates a dramatic illusion frame effect.



DESIGN GUIDELINES

- Maximum size for 6mm, 10mm, 12mm is 60" x 120" (1524mm x 3048mm)
- Minimum dimension for polished flat edge is 4" (101.6mm)
- High quality paint on transparent or satin glass types
- Available in 6mm, 10mm or 12mm glass.
- Border thickness available in any size width
- Standard painted border = 2 1/4" (57mm)
- Custom painted border dimensions available upon request

Pictured: Glass Countertop with Custom Backpainted °elusion Border

GLASS MARKERBOARDS

GLASS MARKERBOARDS

Custom backpainted glass magnetic markerboards make beautiful and functional work surfaces. Unlike other writable surfaces, glass is a material which will not fade or ghost over time making it the premium markerboard product. Available in both writable matte and gloss glass in nearly any size and color.



DESIGN GUIDELINES

- Maximum size is 48" x 120"
- Available in gloss or writable matte glass
- Magnetic or non-magnetic option available
- All edges will be flat edge polished
- Custom colors require sample approval and fees may apply
- Wall mounting hardware (Z-Clip) is included, orientation must be specified
- Magnetic markerboards must be used with rare earth neodymium magnets only
- Markerboard trays and accessory kits available
- Magnetic glass can be used as an insert option on our aluminum frame cabinet doors

Pictured: White Gloss Glass Markerboards

[< back to table of contents](#)



Monday-meeting
11:00am w/ Carlton

MARKERBOARD MOUNTING HARDWARE

Z-clip (french cleat) mount is pre-installed on all boards and the wall mounting hardware is also included. Once installed markerboards are less than 1/2" from wall.

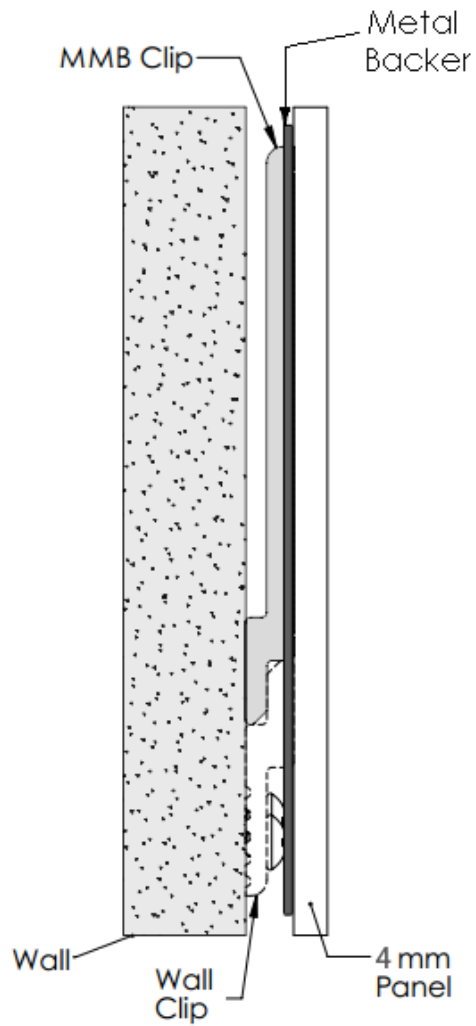

Pictured: Sand Writable Matte Glass Markerboards

QUICK SHIP MARKERBOARDS



MAGNETIC GLASS MARKERBOARD

QUICK SHIP PROGRAM DETAILS

- Tempered safety glass
- Non-magnetic backer optional
- Gloss or writable matte glass
- Pre-Installed z-clip for easy wall mounting
- Magnetic marker trays and glassboard accessories including markers, erasers, cleaning spray, rare earth magnets also available.



STANDARD SIZES



large: 48" x 36"
(horizontal or vertical)



medium: 36" X 24"
(horizontal or vertical)



small: 18" X 18"

QUICK SHIP COLORS

GLOSS & WRITABLE MATTE GLASS AVAILABLE

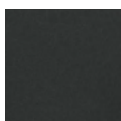

black



slate



mist

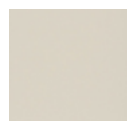

sand



cream

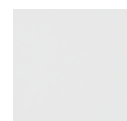

white

GLASS MARKERBOARD ACCESSORIES

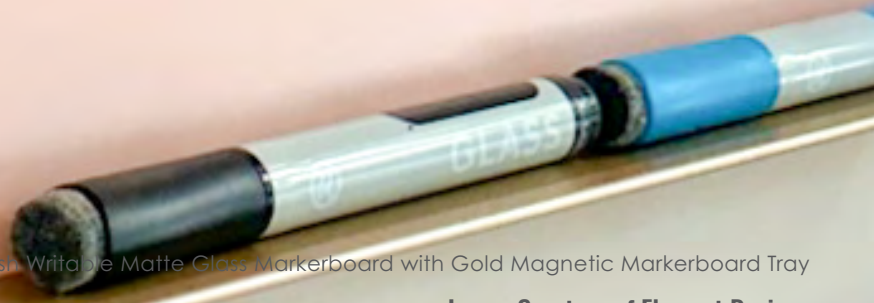
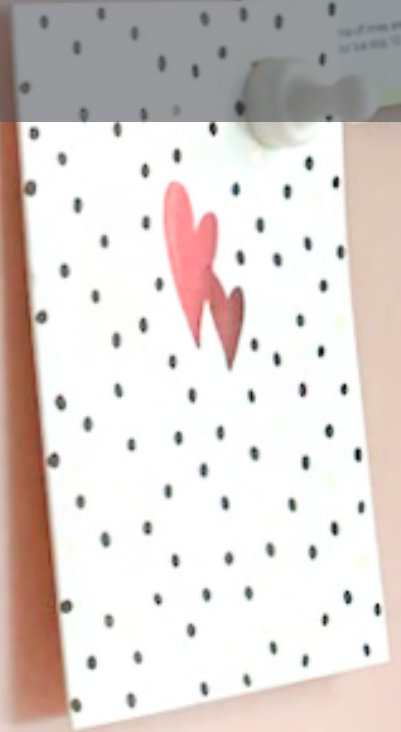
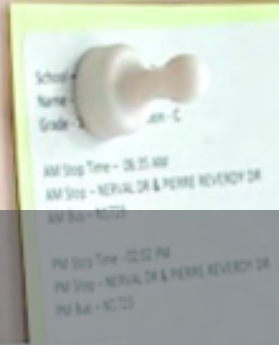

Pictured: Blush Writeable Matte Glass Markerboard with Gold Magnetic Markerboard Tray

Image Courtesy of Element Designs

MARKERBOARD ACCESSORY KITS



standard kit



starter kit

MAGNETIC MARKER TRAYS



°eCUBED SHELVING SYSTEMS



Element Designs' shelving systems provide fully integrated and complete storage solutions for residential and commercial spaces. Our modern shelving designs combine contemporary style and exceptional materials into elegant easy-to-install units. Our °eCubed Shelving Systems can be built around existing wood shelving along with a variety of our glass shelving options, including standard, backpainted, custom color backpainted, °elusion and more.



°eCubed Shelving System, Onyx



°eCubed Shelving Ladder, Onyx



°eCubed Shelving System, Brushed Stainless

°eCUBED SHELVING



ALUMINUM SHELVING SOLUTIONS



DESIGN GUIDELINES

- Shelves can be inset to sit inside the framing or lay across the top
- Additional support required every 48"
- Shelf thickness of 6mm recommended when inset
- Frames are compatible with any existing or customer supplied shelf material (not supplied by Element Designs)
- Shelving units can ship fully or partially assembled

GLASS SHELF OPTIONS



- Glass used for shelving is 6mm thick with polished flat edges
- Backpainted Glass shelves are also available

Pictured: eCubed Shelving System in Modern Brass Finish with Low-Iron Clear Glass Shelves

[< back to table of contents](#)

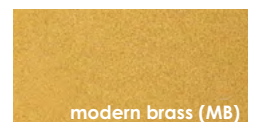
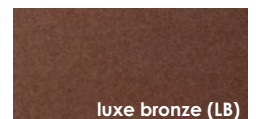
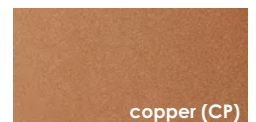
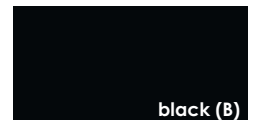
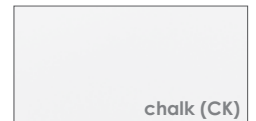
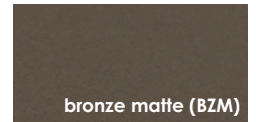
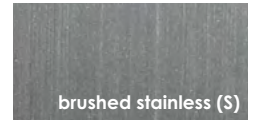



°eCUBED ALUMINUM FRAME COMPONENTS

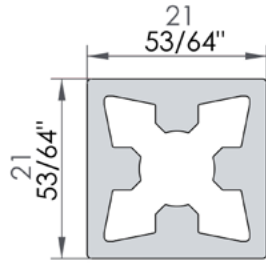

vertical tubing

horizontal tubing

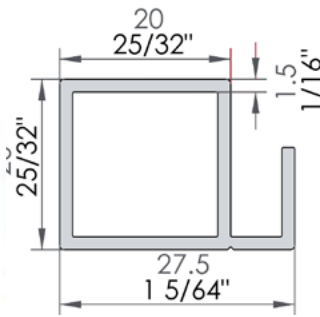
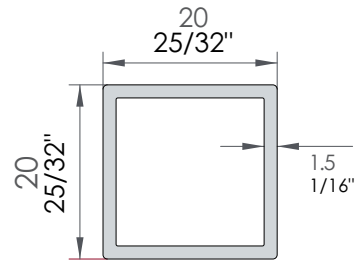
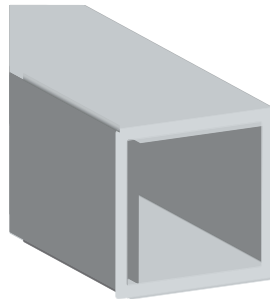

horizontal shelf tubing

ASSEMBLY DETAILS

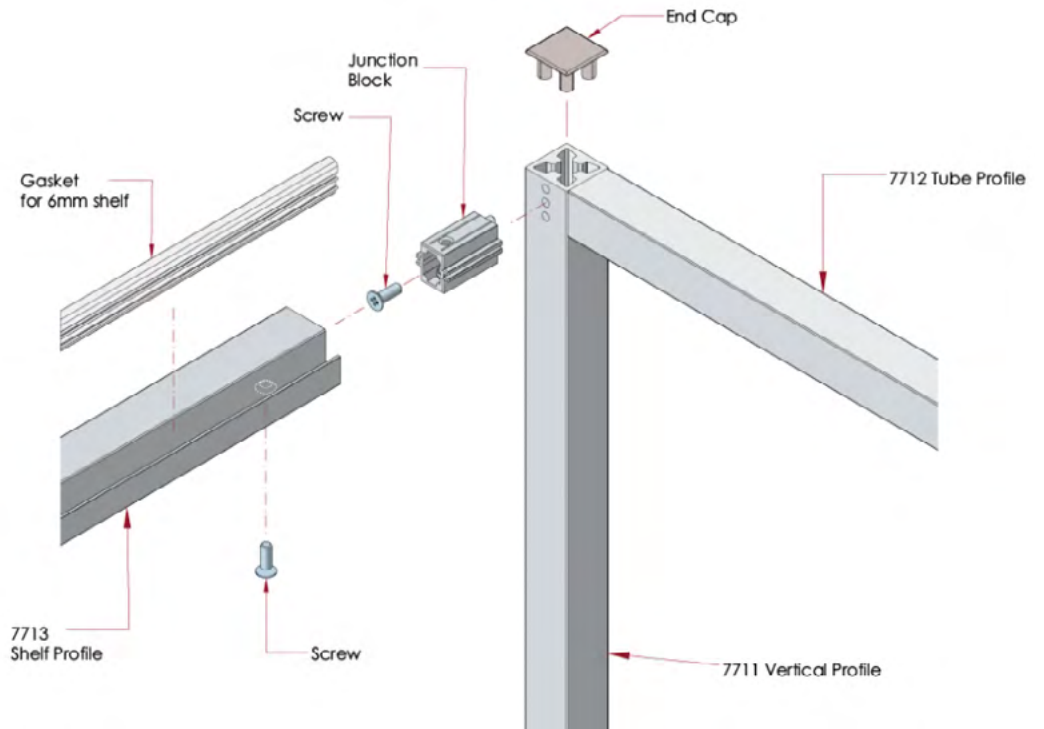

Pictured: °eCubed Shelving System in Onyx Finish with Low-Iron Clear Glass Shelves

°eCUBED LADDER



LADDER SHELVING BRACKETS

DESIGN GUIDELINES

- Ladder design allows shelves to sit across full depth of frame
- Frame configuration can accommodate up to 8 shelves
- Compatible with any shelf material (not supplied by Element Designs)
- Wood shelf mounting holes available upon request.
- Custom sizing offers open shelving of various widths, heights and depths
- Shelving configuration and individual ladder size will determine the number of aluminum frame brackets required.

COMPATIBLE SHELVING

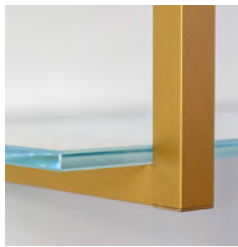

glass



wood



laminate

Glass Shelving Options - 6mm, 10mm, & 12mm

low-iron
clearlow-iron
satin

clear

satin

Glass Shelving Options - 6mm only



grey clear

bronze
clear

- Glass has polished flat edges.
- Backpainted Glass options are also available.
- dECOMatte 12mm material can be used for shelving.



natural aluminum (N)

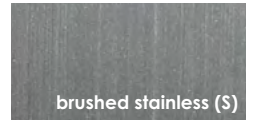

brushed stainless (S)

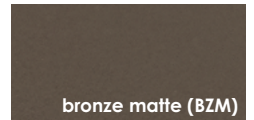

bronze matte (BZM)

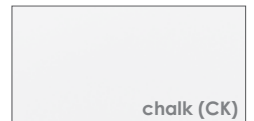

chalk (CK)



onyx (X)

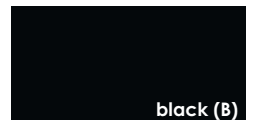

black (B)



arctic silver (AS)

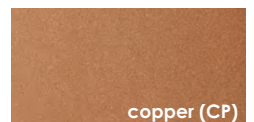

copper (CP)



gold (GLD)

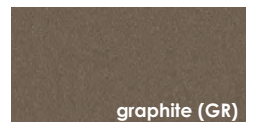

graphite (GR)



luxe bronze (LB)

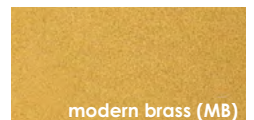

modern brass (MB)

116

GLASS SHELVES

GLASS SHELVES

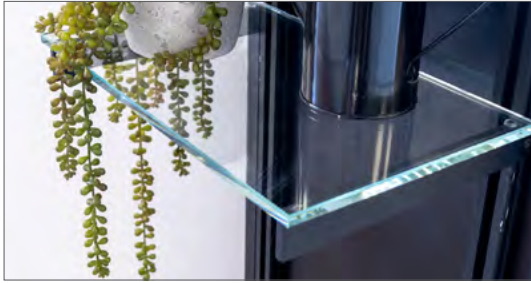

standard glass



backpainted glass

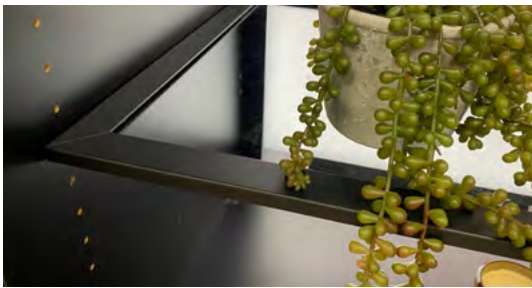

aluminum framed glass



elusion glass

DESIGN GUIDELINES

- Available in 6mm (1/4"), 10mm (3/8") and 12mm (1/2") thickness
- Standard glass options same as eCubed.
- Backpainted glass available in all standard and custom colors
- elusion borders can be any backpainted with any color or border size
- Tempered safety glass with polished flat edges

ALUMINUM FRAME SHELVING OPTION

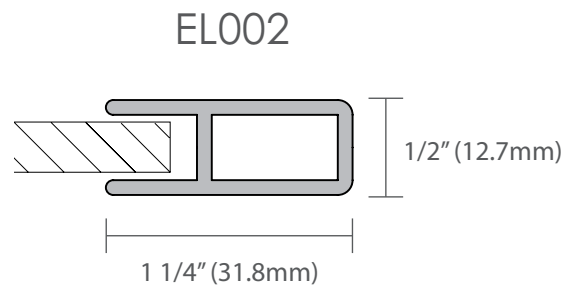

Pictured Left: Glass Shelves in Low-Iron Clear Glass

BASE SYSTEMS



Element Designs' base systems are a sleek, modern and unique product solution for all types of cabinet and furniture designs. They are used primarily as a base for kitchen islands, bathroom vanities, cabinets, tables, desks, and also as standalone open shelving solution. Layouts include various standard configuration options. Custom configurations are also available.

Our aluminum frame base systems come in 30mm (1 3/16") and 50mm (2") width aluminum frame square tubing. They are available in all our anodized and coated finish options. Support solutions include leveling feet, casters, and end caps. Decorative cuff is also available for base systems designed with leveling feet or caps.



BS001, Natural Aluminum



Image Courtesy of Wellborn Cabinet

BS002, Onyx



Image Courtesy of Wellborn Cabinet

BS001, Brushed Stainless



50MM BASE SYSTEM FRAME



BASE SYSTEMS - BS001

Our larger base system design, BS001, is a 50mm hollow aluminum frame. Applications include table, desk, island and vanity bases. Every configuration is hand built to custom size specifications.

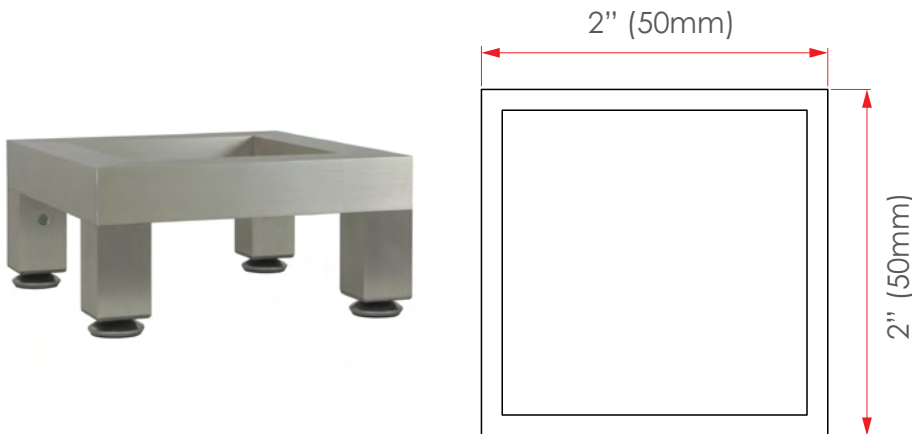

BS001 CUFF

- Square cuff measures 1.5" x 1.5" (38mm x 38mm)
- Available in all finishes, except brushed stainless.
- Cannot be used with caster wheel



SUPPORT OPTIONS



Pictured: BS001 Profile in Brushed Stainless with Caster



30MM BASE SYSTEM FRAME



BASE SYSTEMS - BS002

Our smaller base system design, BS002, is a 30mm hollow aluminum frame. Applications include table, desk, island and vanity bases. Every configuration is hand built to custom size specifications.

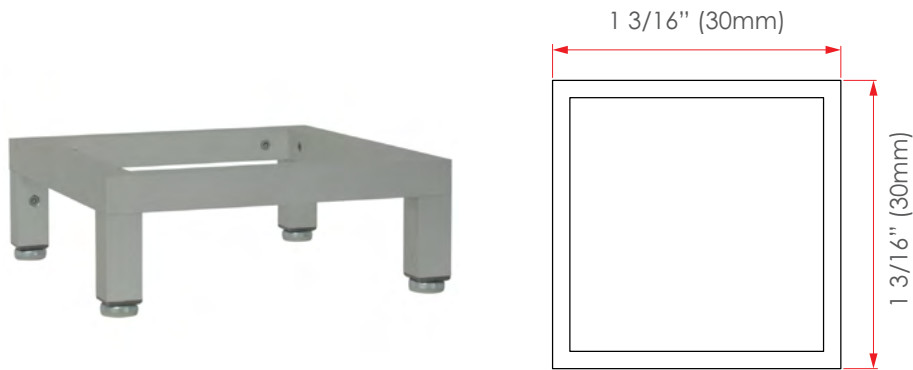

BS002 CUFF

- Square cuff measures 1.5" x 1.5" (38mm x 38mm)
- Available in all finishes, except brushed stainless.
- Cannot be used with caster wheel



SUPPORT OPTIONS



Pictured: BS002 Profile in Brushed Stainless with End Cap



CONTRACT COATING



WHAT IS SPECIALTY CONTRACT COATING?

Specialty coating used for aluminum finishes is now available as a service for customer provided parts. Water-based coating is an environmentally friendly paint that can be applied to a variety of materials including aluminum, steel, and plastic.



Pictured Left: Customer Occasional Tables Coated in Gold, Arctic Silver, & Copper Specialty Finishes

Pictured Above: Desk Trim Components Coated in Onyx Specialty Finish

bronze matte (BZM)

chalk (CLK)

onyx (X)

black (B)

arctic silver (AS)

copper (CP)

gold (GLD)

graphite (GR)

luxe bronze (LB)

modern brass (MB)

[< back to table of contents](#)

SAMPLE KITS & MORE

LUMINUM FRAME DOORS

FRAMELESS GLASS DOORS

ELEMENT DESIGNS' ONLINE SAMPLE STORE

Element Designs' offers a vast array of standard sample products including sample kits and individual product, frame, finish and glass samples. All samples are available for purchase on our online sample store store.element-designs.com.



Inspiration Kit



Designer Kit



Backpainted Glass Kit



CLICK HERE TO VISIT THE SAMPLE STORE

STORE.ELEMENT-DESIGNS.COM

[< back to table of contents](#)

SHOWROOM DESIGN CENTER

ROTATING PEDESTAL TOWER THAT DISPLAYS OUR LARGEST COLLECTION OF SAMPLES INCLUDING 12 DOORS, 15 PROFILE CORNERS, 12 FINISH SAMPLES, & OVER 60 INSERTS. OTHER PRODUCTS LIKE BACKPAINTED GLASS, ELUSION, DECOLUXE, DECOMATTE, FRAMELESS GLASS DOORS & MARKERBOARD SAMPLES ALSO INCLUDED AS LOOSE SAMPLES.

TOWER IS 24" X 24" X 76" WITH BUILT-IN CABINET FOR STORAGE.



AVAILABLE TO ORDER USING OUR ONLINE SAMPLE STORE

Individual replacement samples also available online. Contact your local sales representative for information on current showroom discounts.

For the most up to date version, please see our online checklist and suggested customer layout: element-designs.com/technical/sdc-checklist.pdf





INTERACTIVE DISPLAY LAYOUT

- Display up to 12 aluminum frame door profile corners. 14 included.
- Display up to 28 of the 4x4 insert samples. Over 60 included.
- All aluminum samples include j-hangers for easy install.
- Designed to mix & match profile, finish, and insert options.



Space for 12 Profile Corners to hang with attached J-Hangers

Space for 9 Finish Samples to hang with attached J-Hangers

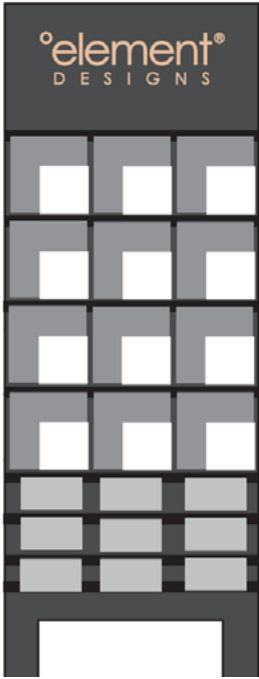

Space for 24 Insert Samples to slide into attached mounts

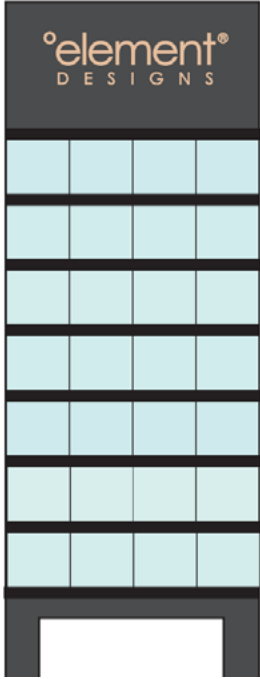



ABOUT US

SUSTAINABLY MADE IN THE USA

Combining sustainability and regionally sourced materials has always been at the core of what we do and the products we make. Our manufacturing facility is located in Fort Mill, SC and every product is hand crafted by our incredible team.

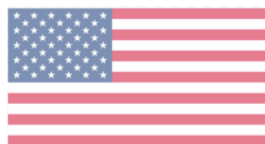



OUR PRODUCTS

Element Designs is the leading manufacturer of aluminum frame and glass cabinet doors in North America. We also offer custom shelving solutions, drawer fronts, magnetic markerboards, sliding door systems, dECOLuxe high gloss solid acrylic, dECOMatte thin surfaces and have an extensive backpainted glass program. Our name is synonymous with design innovation and modern function within the residential and commercial industries. With an unrivaled selection of styles, frames, finishes, inserts and more, our products have endless options that are tailored to each design and custom for every space. We have exceptional standards in both production and customer care and we look forward to creating custom pieces for you and your clients.

[< back to table of contents](#)



SUSTAINABILITY

“ We live on a planet that has a limited ecosystem and what we do has a large impact on our environment. This means that having a sustainable business is imperative to your survival as a company. ”

**– Mike Uebersax,
President & CEO of Element Designs**

When defining what it means to be sustainable; the material, product, and/or process must have not only a low impact on the environment itself but it must possess characteristics that by definition help prolong and sustain it's lifecycle.

At Element Designs, sustainability has always been at the core of what we do and the products we make. Some of the key materials we use, including aluminum and glass are naturally and inherently sustainable. Other materials like our dECOLuxe Solid Acrylic were sought out specifically because it is not only made from 100% recycled acrylic, but it is also 100% recyclable.

In addition to the materials we use, the way in which we manufacture our products has evolved to become much more sustainable and eco-conscious. This is something we continuously strive to work towards and as the available resources grow, they are giving us the ability to make a significant impact in the preservation of our planet. We will continue to innovate the ways in which we produce our products and hope you can join us on our mission to leave this world a better place than we found it.

Aluminum

All aluminum products are manufactured using materials from regional suppliers in an effort to reduce our carbon footprint. Our aluminum products are exceptionally durable, have an extremely long lifespan and are virtually maintenance free.

Aluminum extrusion waste generated during manufacturing is taken to a local metal recycling facility here in Fort Mill, SC. Our aluminum materials and products are 100% recyclable.

We encourage the reusing and repurposing of all aluminum doors. This is easily done by replacing components within and around existing aluminum doors and frames.

Glass

All of our glass material contains at least 20% post industrial recycled content. The architectural resin used for our 3Form® inserts also yields a high percentage of post industrial recycled material.

Unusable glass generated during manufacturing is reused in asphalt production. Our glass materials and products are 100% recyclable.

Acrylic

Element Designs is the exclusive fabricator of dECOLuxe Solid Acrylic for North America. It is made of 100% recycled acrylic and is 100% recyclable, using PMMA (Polymethyl Methacrylate) which is the only plastic that can be recycled back to its original raw material: Monomer.

During manufacturing, dECOLuxe uses less water and generates less CO2 than standard cast acrylic sheets. It is also VOC (Volatile Organic Compound) and HFC (Hydrofluorocarbon) free.

Facility

None of our products contain VOC's. Our backpainted glass process uses environmentally safe water based paint. Zero chemicals or toxins are released from our products, there is zero effect on indoor air quality.

We offer full-service reclamation on all of our products. Instead of discarding them or throwing them away, we encourage our customers to return products for complete and proper recycling at no charge.

Our packaging materials are regionally sourced. To protect our products in transit we use corrugated edge wrapping and honeycomb foam alternative, which are made from 100% recycled cardboard. For void fill we use biodegradable plastic air fill. Within our production space and company office we recycle all cans, glass, plastic bottles and paper products. We also actively promote the importance of environmental responsibility and are proud to sponsor a recycling center for our industrial park.





CONTACT ELEMENT DESIGNS

info@element-designs.com

element-designs.com

7107 Logistics Lane, Suite 101

Fort Mill, SC 29715

Need samples? Visit our online store at

store.element-designs.com

@elementdesignsinc



[< back to table of contents](#)